



Mast Pak

Surgical Corporation

Manufacturer & Exporters of surgical instruments



Mast Pak Surgical Corp.
Gynecology Instruments

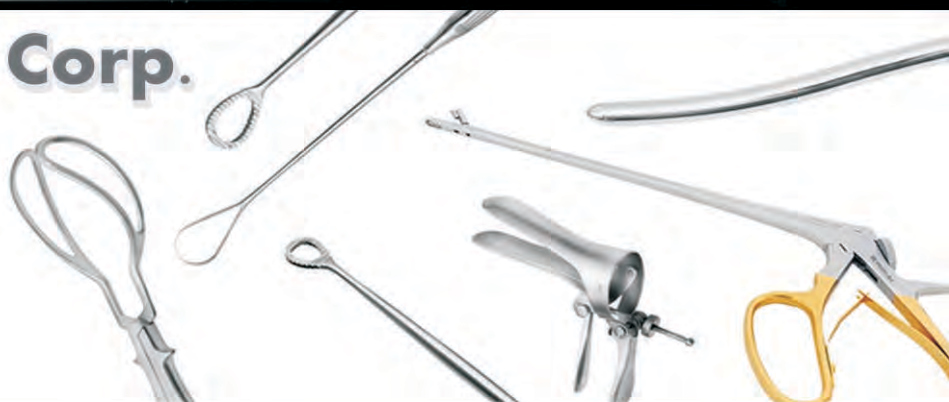

Website: www.mastpaksurgicalcorp.com
Email: info@mastpaksurgicalcorp.com
Phone: +92-324-8609456
Address: Pacca Garha, Kashmir Road
Sialkot 51310, Pakistan

About us:

A team of professional experts joined hands to form MAST PAK SURGICAL CORPORATION with the sole aim to export high Quality surgical Instruments, Specialist in Needle Holder Forceps with Tungsten carbide.

Our products were advertised throughout the world by the help of catalogues, Internet, Exhibitions & personal visits to different countries of the world. These efforts bore fruit and we managed to establish our credibility and began exporting our products.

MAST PAK SURGICAL CORPORATION achieved tremendous success by virtue of constant dedicated efforts, devotion to duty and maintenance of quality control. This quality management system was properly implemented and is being successfully executed at all production stages, which indeed a result of constant professional and vigorous team effort undertaken by MAST PAK SURGICAL CORPORATION most responsible, professional and dedicated staff members.

Its always been our endeavor to maintain a high standard of production, quality control and customer satisfaction. We finally offer our sincere regard and gratitude to all our valued clients for patronizing MAST PAK SURGICAL CORPORATION and helping us to achieve our goals.

Our Mission

Establish a global presesnce as a leading designer and manufacturer of high quality handled surgical instruments in the dental and medical surgical fields.

Our goal will be achieved through the offering of excellent products and services: and by our commitment of exceed customer expectations.

Achievements

High achievement always takes place in the framework of high expectations.

Gynecology Clamps

Hemostatic forceps, clamp-forceps, hysterectomy and vaginal forceps
Pincas hémostatiques, pincas-clamps, pincas à hystérectomie et vaginales
Pinzas hemostáticas, pinzas-clamps para histerectomía y vaginales



Hemostatic forceps, clamp-forceps, hysterectomy and vaginal forceps
Pincas hémostatiques, pincas-clamps, pincas à hystérectomie et vaginales
Pinzas hemostáticas, pinzas-clamps para histerectomía y vaginales



Hemostatic forceps, clamp-forceps, hysterectomy and vaginal forceps
Pincas hémostatiques, pincas-clamps, pincas à hystérectomie et vaginales
Pinzas hemostáticas, pinzas-clamps para histerectomía y vaginales



Parametrium

Hemostatic forceps, clamp-forceps, hysterectomy and vaginal forceps
Pincas hémostatiques, pincas-clamps, pincas à hystérectomie et vaginales
Pinzas hemostáticas, pinzas-clamps para histerectomía y vaginales

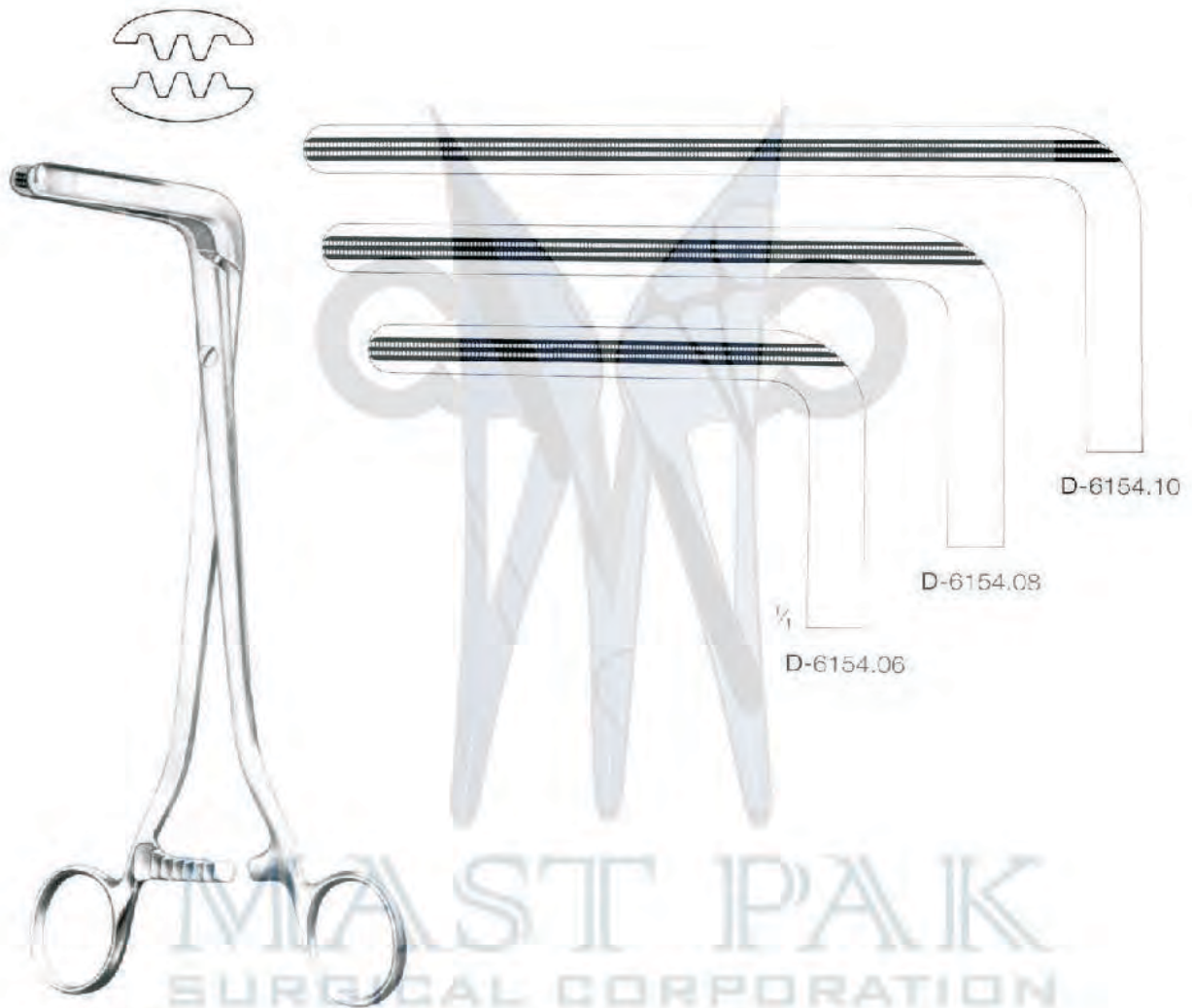

Wertheim
24 cm/9 1/2"

MAST PAK
SURGICAL CORPORATION

Peritoneal clamp forceps
Pinces-clamps pour le péritoine
Pinzas-clamps para peritoneo



Baby-Mikulicz
 14 cm/5 1/2"
 D-6201.14

Mikulicz
 20 cm/8"
 D-6201.20

Mikulicz
 20 cm/8"
 D-6207.20

Mikulicz
 18,5 cm/7 1/2"
 D-6209.18



Mikulicz
 18 cm/7"
 D-6221.18

Mikulicz
 20 cm/8"
 D-6223.20

Mikulicz
 20 cm/8"
 D-6225.20

Mikulicz
 23 cm/9"
 D-6229.23

sturdy pattern

laterally curved

Peritoneal clamp forceps
Pinces-clamps pour le péritoine
Pinzas-clamps para peritoneo

Hysterectomy forceps
Pinces à hystérectomie
Pinzas-clamps para histerectomía

Peritoneal Clamp Forceps



Schindler
 19 cm/7 1/8"
 D-6241.19



Faure
 20 cm/8"
 D-6243.20



Faure
 20 cm/8"
 D-6245.20

Hysterectomy Forceps



| Heaney | cm | inch. | Heaney |
|-----------|----|-------|-----------|
| D-6321.21 | 21 | 8 1/4 | D-6323.21 |
| D-6321.23 | 23 | 9 | D-6323.23 |
| D-6321.25 | 25 | 10 | D-6323.25 |



Peritoneal clamp forceps
Pinces-clamps pour le péritoine
Pinzas-clamps para peritoneo

Hysterectomy forceps
Pinces à hystérectomie
Pinzas-clamps para histerectomía

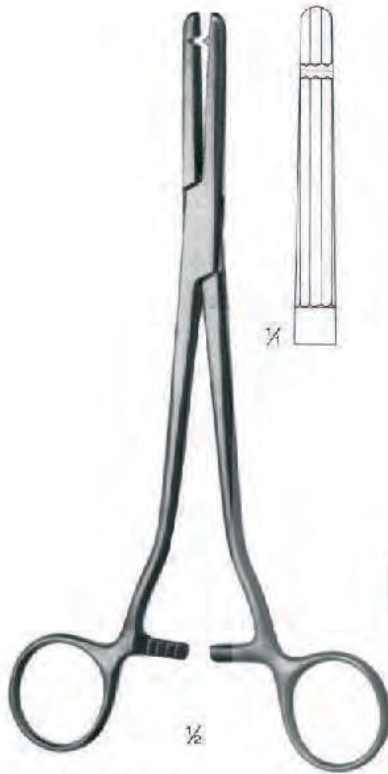

Ballentine
 21,5 cm/8 1/2"
 D-6330.21

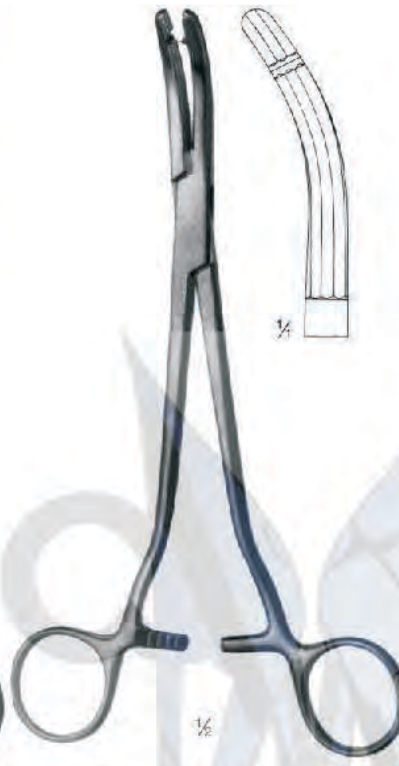

Heaney-Ballentine
 21,5 cm/8 1/2"
 D-6331.21

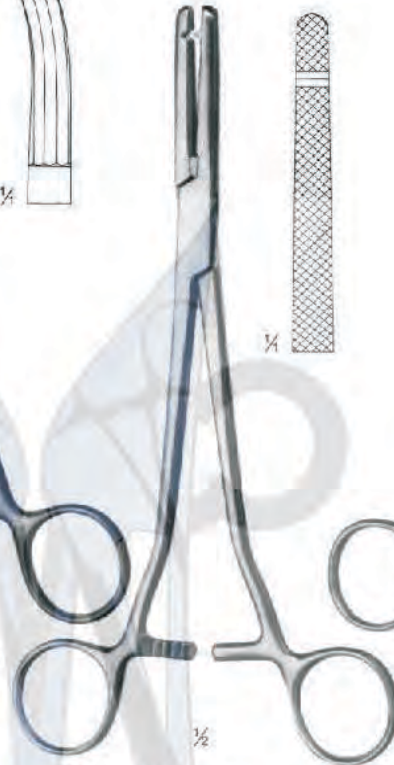

Heaney-Rezek
 21,5 cm/8 1/2"
 D-6338.21



Heaney-Kanter
 21,5 cm/8 1/2"
 D-6341.21



Wiener Modell
 D-6361.20 = 20 cm/8"
 D-6361.22 = 22 cm/8 1/2"
 D-6361.25 = 25 cm/10"



22 cm/8 1/2"
 D-6363.22

25 cm/10"
 D-6363.25

Wiener Modell (Walzl)

Uterine polypus forceps, ovarian forceps
Pinces à polypes utérins, pinces pour les ovaires
Pinzas para pólipos uterinos, pinzas para ovarios



Heywood-Smith
20 cm/8"
D-6410.20

Heywood-Smith
21 cm/8 1/4"
D-6412.21

Heywood-Smith
25 cm/10"
D-6414.25

Noto
27 cm/10 1/2"
D-6420.27

Uterine polypus forceps, uterine elevating forceps
Pincès à polypes utérins, pincès hystérolabes
Pinzas para pólipos uterinos, pinzas histerolabos

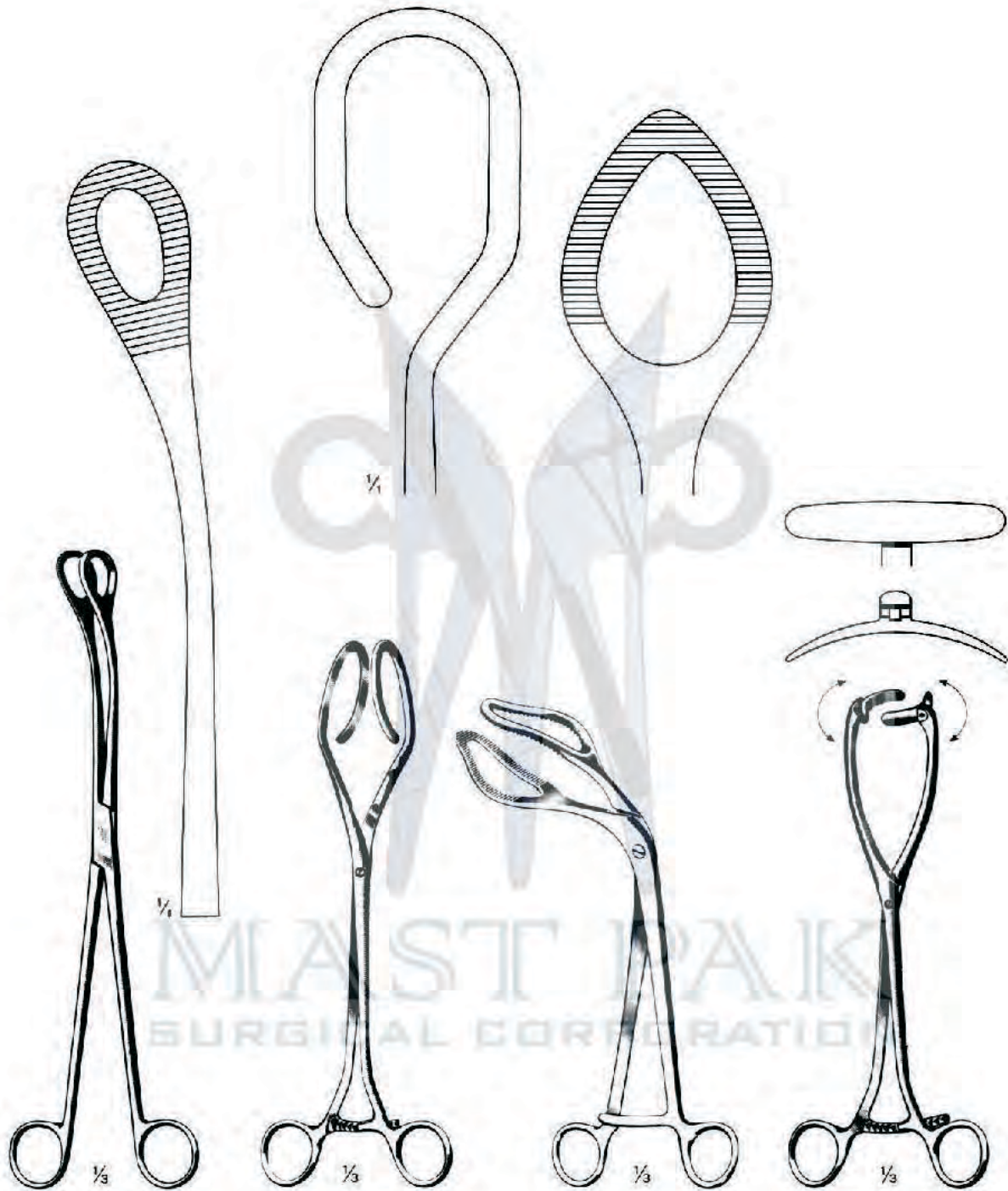

Kelly
32 cm/12 1/2"
D-6420.32

Dartigues
27 cm/10 1/2"
D-6430.27

Somer
23 cm/9"
D-6435.23

Collin
25 cm/10"
D-6442.25

**Obstetrics
Accouchements
Obstetricia**

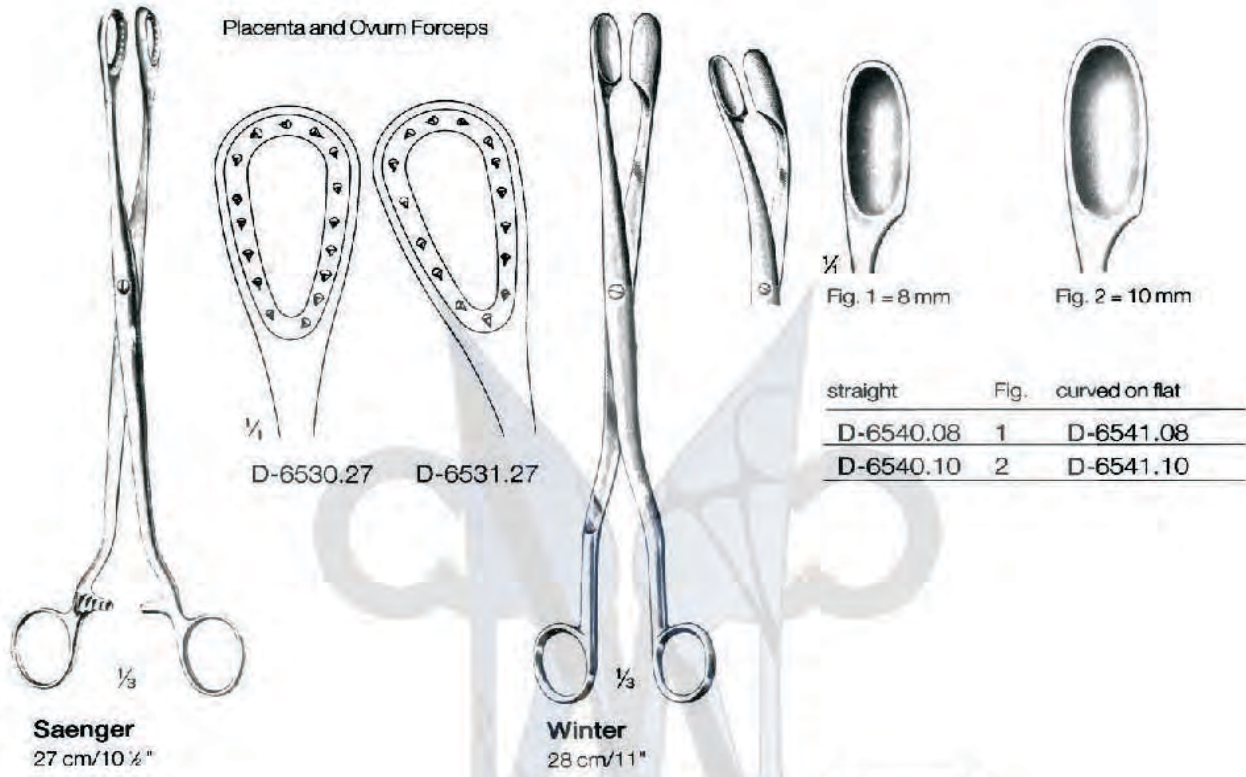

Tenaculum forceps
Pinces pour abaissement du col de l'utérus
Pinzas para coger el cuello del útero



Hulka
30 cm/12"
D-7001.30

Abel
27 cm/10 7/8"
D-7010.27

Schroeder
25 cm/10"
D-7016.25

Tenaculum forceps
Pinces pour abaissement du col de l'utérus
Pinzas para coger el cuello del útero



Duplay
28 cm/11"
D-7051.28

Skene
24 cm/9 1/2"
D-7053.24

Pozzi
25,5 cm/10 1/4"
D-7056.25

Collin-Pozzi
25 cm/10"
D-7058.25

Tenaculum forceps
Pinces pour abaissement du col de l'utérus
Pinzas para coger el cuello del útero

Towel Forceps



Staude-Moore (Bernhard)
 17 cm/6 3/4"
 D-7082.17

Barrett
 18 cm/7"
 D-7084.18

Iowa
 26 cm/10 1/4"
 D-7107.26

Jacobs
 21 cm/8 1/4"
 D-7130.21 straight

Tenaculum forceps
Pinces pour abaissement du col de l'utérus
Pinzas para coger el cuello del útero



Museux
 24 cm/9 1/2"
 D-7218.24

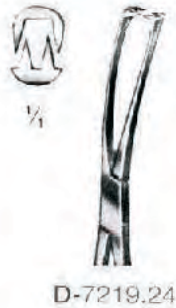

D-7219.24



Museux
 24 cm/9 1/2"
 D-7224.06 = 6 mm
 D-7224.08 = 8 mm
 D-7224.10 = 10 mm



Museux
 24 cm/9 1/2"
 D-7225.06 = 6 mm
 D-7225.08 = 8 mm
 D-7225.10 = 10 mm

curved sideways



Teale
 23 cm/9"
 D-7243.23



Schroeder
 24 cm/9 1/2"
 D-7400.24



Schroeder
 24 cm/9 1/2"
 D-7401.24



curved on flat



Schroeder
 24 cm/9 1/2"
 D-7403.24



curved sideways

MASTIPAK SURGICAL CORPORATION

Tenaculum forceps
Pinces pour abaissement du col de l'utérus
Pinzas para coger el cuello del útero

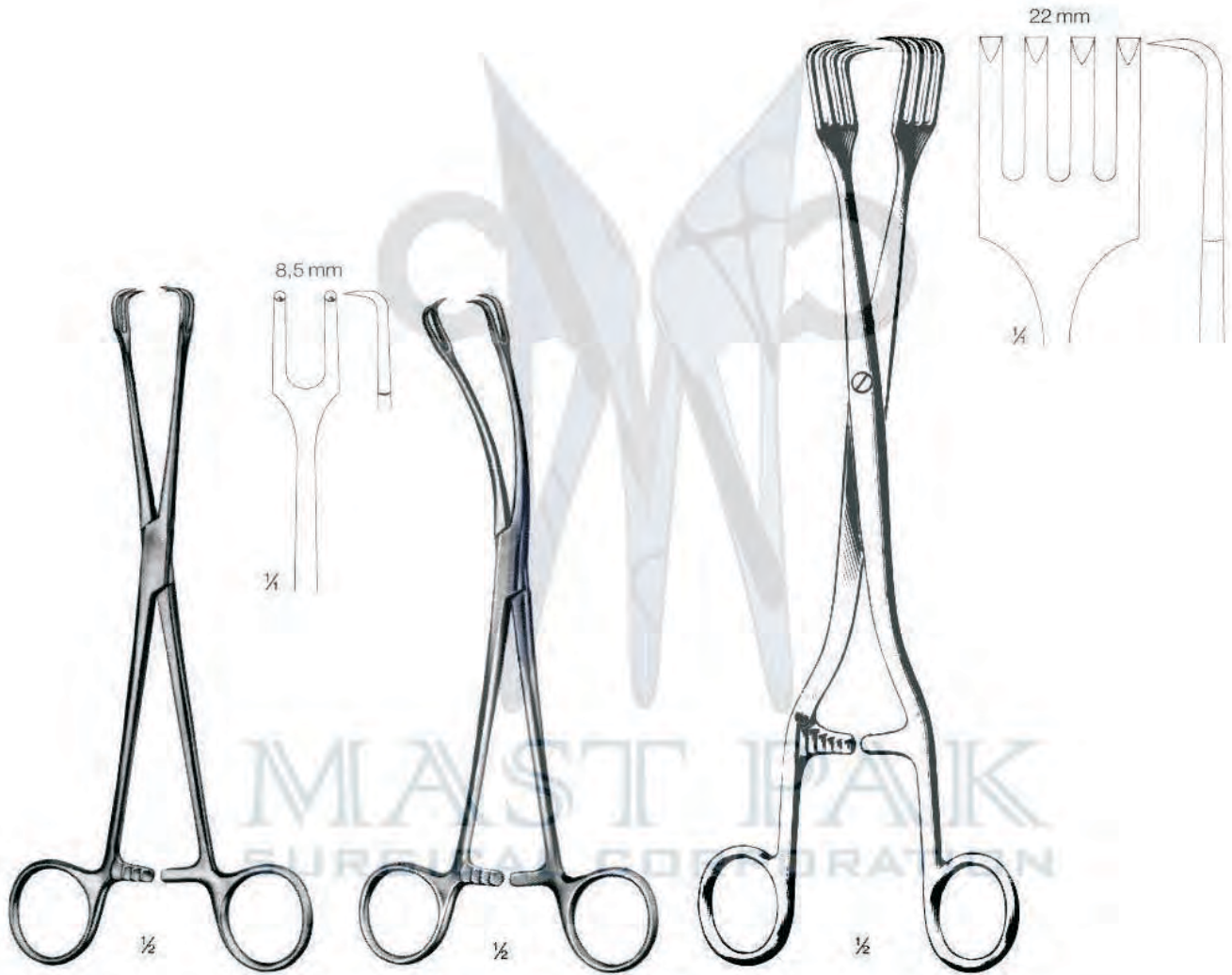

Museux
20 cm/8"
D-7464.20

Museux
20 cm/8"
D-7465.20

Pratt
28 cm/11"
D-7648.28

Polypus and dressing forceps, cotton swab forceps, foreign body forceps
Pinces à polypes et à pansements, pincés à tampons, pincés à corps étrangers
Pinzas para pólipos y vendajes, pinzas para tapones, pinzas para cuerpos extraños

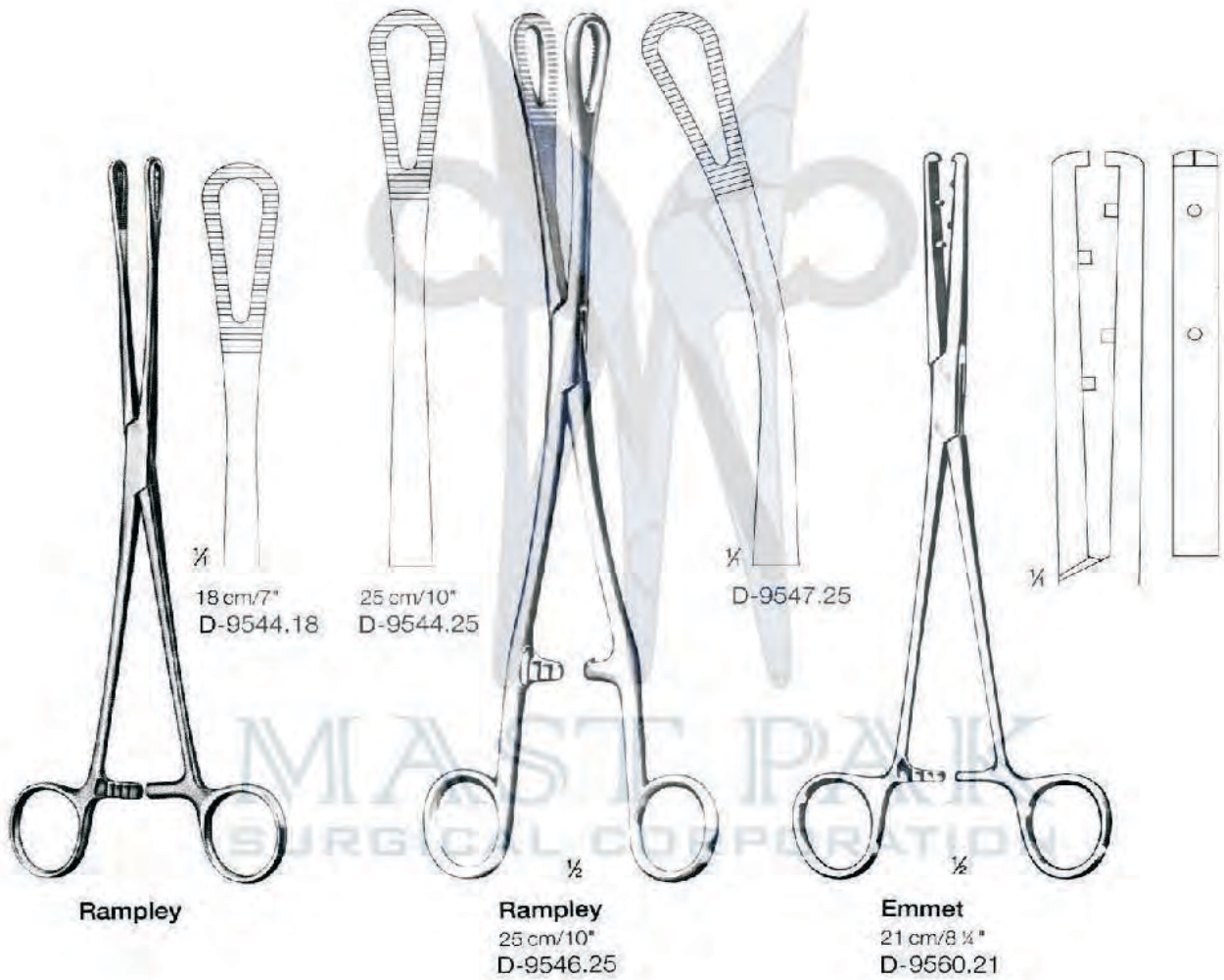

Polypus and dressing forceps, cotton swab forceps, foreign body forceps
 Pincès à polypes et à pansements, pincès à tampons, pincès à corps étrangers
 Pinzas para pólipos y vendajes, pinzas para tapones, pinzas para cuerpos extraños



Gynecology & Obstetrical Instruments

Urology

Vessie et voies urinaires

Vejiga y vias urinarias

Prostatic Retractors

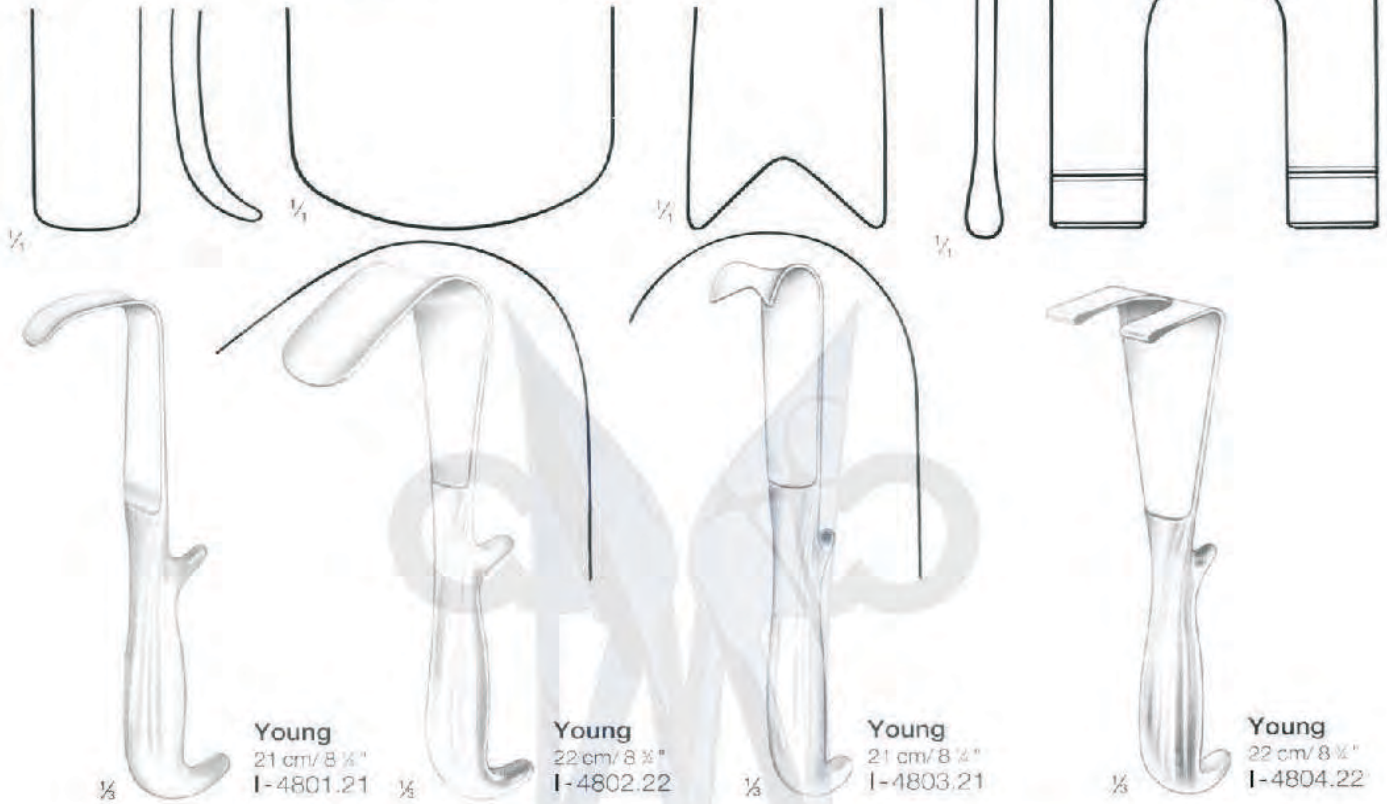

Catheter Introducing Instruments (Guides)

Circumcision instrument



| | Ømm |
|-----------|------|
| I-4910.08 | 8,0 |
| I-4910.11 | 11,0 |
| I-4910.13 | 13,0 |
| I-4910.14 | 14,5 |
| I-4910.18 | 16,0 |
| I-4910.21 | 21,0 |
| I-4910.24 | 24,0 |
| I-4910.26 | 26,0 |
| I-4910.29 | 29,0 |
| I-4910.32 | 32,0 |
| I-4910.35 | 35,0 |

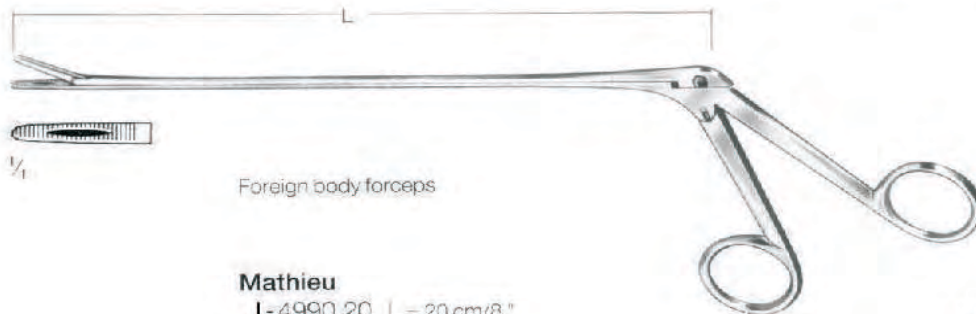

Foreign body forceps

Mathieu

I-4990.20 L = 20 cm / 8"
I-4990.28 L = 28 cm / 11"



Guyon

38 cm / 15"
I-4970.38

Guyon

36 cm / 14"
I-4971.36

Benique

38 cm / 15"
I-4973.38

Gynecology
Gynécologie
Ginecología

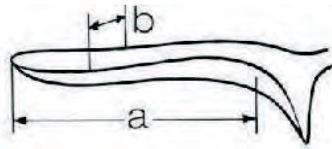

| a mm | b mm | |
|---------|---------|-----------|
| 80 | 24 | H-1040.24 |
| 80 | 32 | H-1040.32 |
| 80 | 36 | H-1040.36 |
| 110 | 37 | H-1040.37 |
| 75 | 17 | H-1040.17 |

Cusco



Swiss pattern

| a mm | b mm | |
|---------|---------|-----------|
| 80 | 22 | H-1050.08 |
| 100 | 25 | H-1050.10 |
| 105 | 27 | H-1050.11 |

Cusco

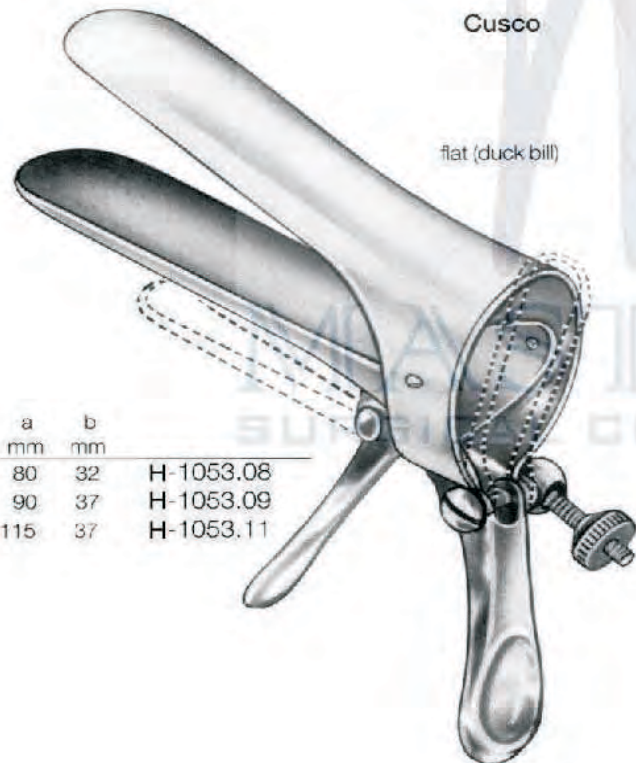

flat (duck bill)

| a mm | b mm | |
|---------|---------|-----------|
| 80 | 32 | H-1053.08 |
| 90 | 37 | H-1053.09 |
| 115 | 37 | H-1053.11 |

Cusco

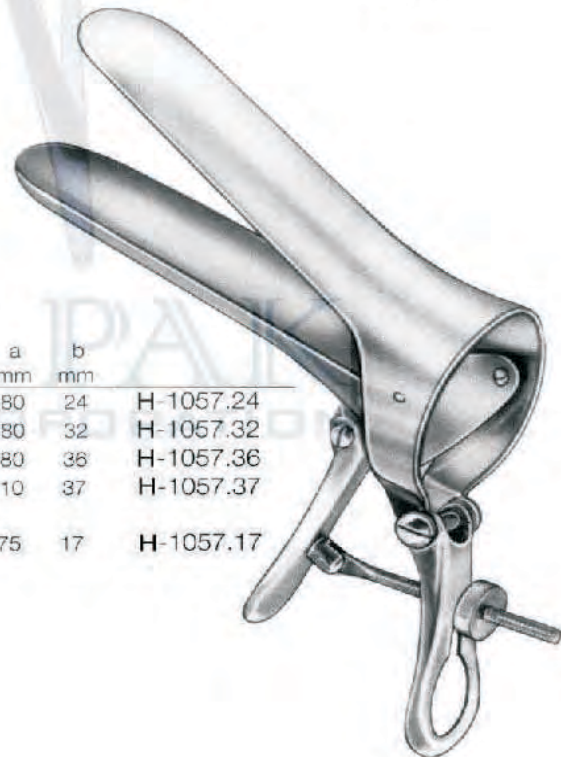

| a mm | b mm | |
|---------|---------|-----------|
| 80 | 24 | H-1057.24 |
| 80 | 32 | H-1057.32 |
| 80 | 36 | H-1057.36 |
| 110 | 37 | H-1057.37 |
| 75 | 17 | H-1057.17 |

Cusco

Gynecology
Gynécologie
Ginecología

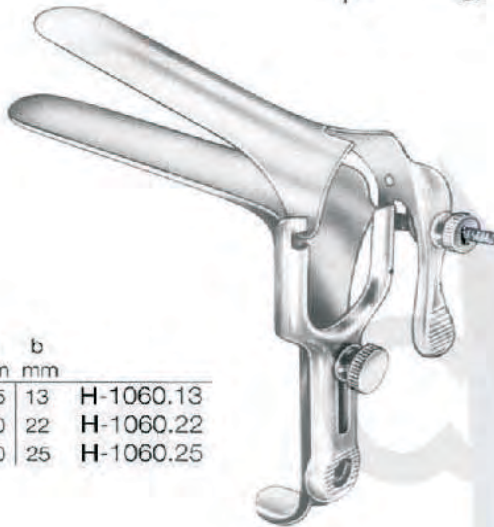
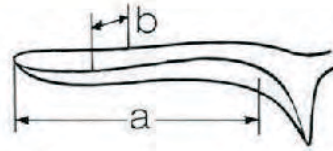

| a | b | |
|-----|----|-----------|
| mm | mm | |
| 75 | 13 | H-1060.13 |
| 100 | 22 | H-1060.22 |
| 120 | 25 | H-1060.25 |

Pederson

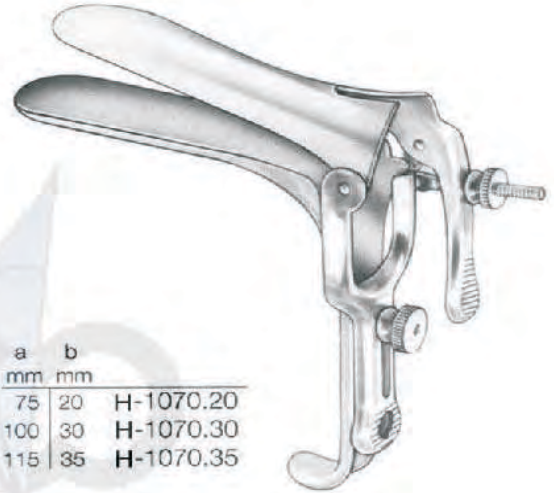

| a | b | |
|-----|----|-----------|
| mm | mm | |
| 75 | 20 | H-1070.20 |
| 100 | 30 | H-1070.30 |
| 115 | 35 | H-1070.35 |

Graves

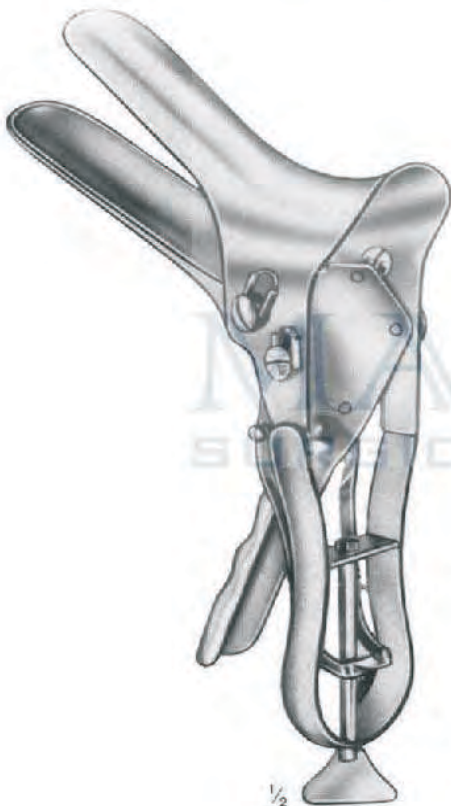

1/2

Seyffert
H-1090.17 100 x 17 mm
H-1090.33 110 x 33 mm

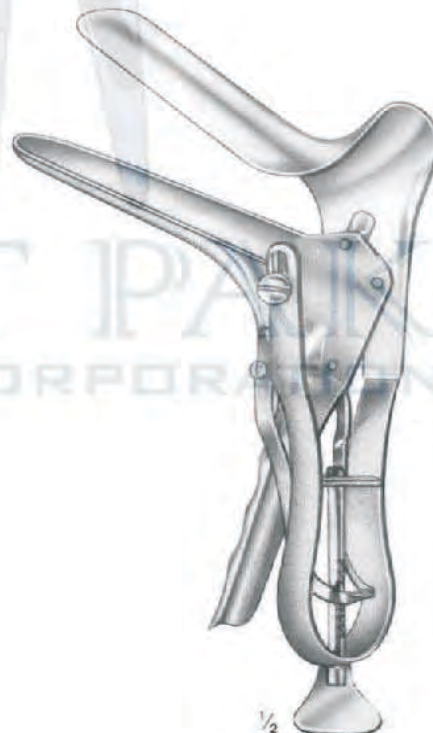

1/2

Seyffert
H-1091.33 110 x 33 mm

Gynecology
Gynécologie
Ginecología

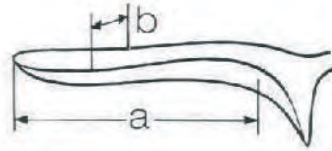

Collin

| a mm | b mm | |
|---------|---------|-----------|
| 90 | 30 | H-1109.30 |
| 95 | 35 | H-1109.35 |
| 105 | 40 | H-1110.40 |

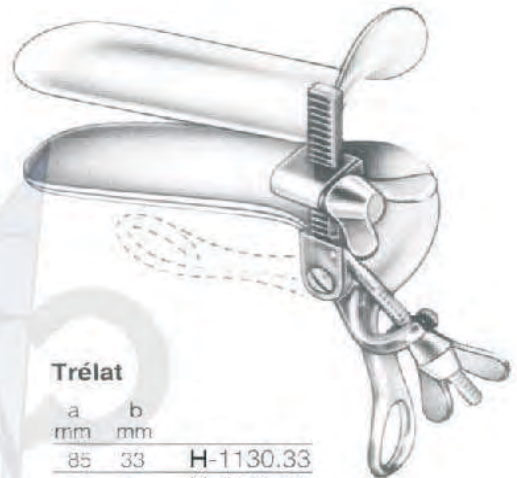

Trélat

| a mm | b mm | |
|---------|---------|-----------|
| 85 | 33 | H-1130.33 |
| 95 | 35 | H-1130.35 |
| 115 | 43 | H-1130.43 |

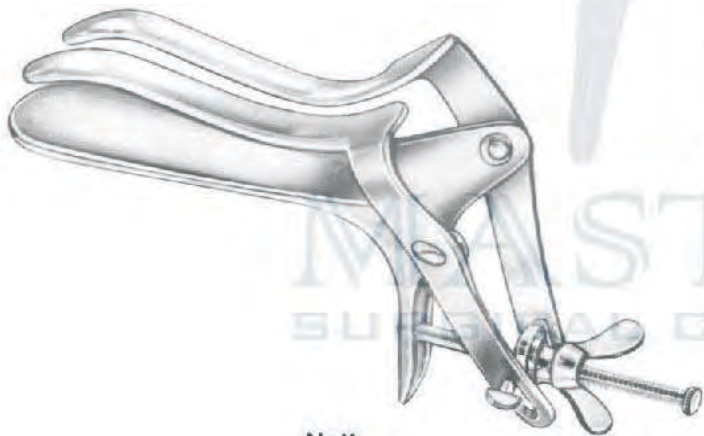

Nott

| a mm | b mm | |
|---------|---------|-------------|
| 90 | 27 | H-1140.27 C |
| 100 | 30 | H-1140.30 C |

chrome plated



Semm

| a mm | b mm | |
|---------|---------|-----------|
| 100 | 17/20 | H-1180.17 |
| 100 | 25/30 | H-1180.25 |

| a mm | b mm | |
|---------|---------|-----------|
| 90 | 14/18 | H-1180.14 |

for children and virgins

Gynecology
Gynécologie
Ginecología

140



1/2 Kristeller



1/2 Kristeller

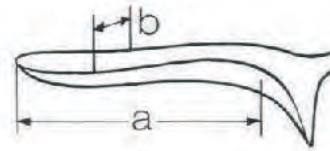

1/2 Kristeller

| | | Specula | | Retractors | | Set of 1 Speculum and 1 Retractor ea. | | | |
|--------|-----------|---------|-------|------------|-----------|---------------------------------------|-------|--------|-----------|
| | | a | b | a | b | | | | |
| Fig. 1 | H-1400.27 | 70 x | 27 mm | Fig. 1 | H-1401.23 | 75 x | 23 mm | Fig. 1 | H-1402.27 |
| Fig. 2 | H-1400.30 | 75 x | 30 mm | Fig. 2 | H-1401.26 | 80 x | 26 mm | Fig. 2 | H-1402.30 |
| Fig. 3 | H-1400.36 | 90 x | 36 mm | Fig. 3 | H-1401.32 | 95 x | 32 mm | Fig. 3 | H-1402.36 |



1/2 Kristeller



1/2 Kristeller



1/2 Kristeller

| | | Specula | | Retractors | | Set of 1 Speculum and 1 Retractor ea. | | | |
|---------|-----------|---------|-------|------------|-----------|---------------------------------------|-------|---------|-----------|
| | | a | b | a | b | | | | |
| Fig. 00 | H-1405.18 | 110 x | 18 mm | Fig. 00 | H-1406.14 | 115 x | 14 mm | Fig. 00 | H-1407.18 |
| Fig. 0 | H-1405.21 | 110 x | 21 mm | Fig. 0 | H-1406.17 | 115 x | 17 mm | Fig. 0 | H-1407.21 |
| Fig. 1 | H-1405.27 | 110 x | 27 mm | Fig. 1 | H-1406.23 | 115 x | 23 mm | Fig. 1 | H-1407.27 |
| Fig. 2 | H-1405.30 | 110 x | 30 mm | Fig. 2 | H-1406.26 | 115 x | 26 mm | Fig. 2 | H-1407.30 |
| Fig. 3 | H-1405.36 | 110 x | 36 mm | Fig. 3 | H-1406.32 | 115 x | 32 mm | Fig. 3 | H-1407.36 |

MASTPAK
SURGICAL CORPORATION

Gynecology
Gynécologie
Ginecología

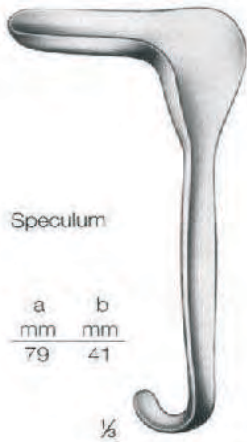

Speculum

| a | b |
|----|----|
| mm | mm |
| 79 | 41 |

1/8

Kallmorgen
H-1450.41

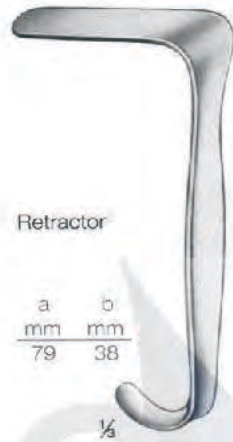

Retractor

| a | b |
|----|----|
| mm | mm |
| 79 | 38 |

1/8

Kallmorgen
H-1451.38

Set

Kallmorgen
H-1452.41

| Fig. | a | b | |
|------|----|----|-----------|
| | mm | mm | |
| 1 | 70 | 27 | H-1480.01 |
| 2 | 75 | 30 | H-1480.02 |
| 3 | 90 | 36 | H-1480.03 |

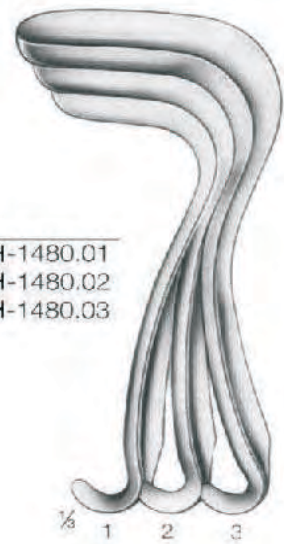

1/8 1 2 3

Sims
18,5 cm / 7 1/4"

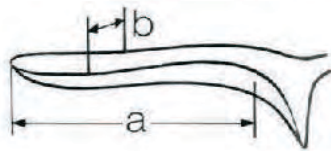

1/8

Sims

| Fig. | a | b | |
|------|----|-------|-----------|
| | mm | mm | |
| 1 | 60 | 25+30 | H-1490.01 |
| 2 | 70 | 30+35 | H-1490.02 |
| 3 | 80 | 35+40 | H-1490.03 |
| | | set | H-1490.00 |



1/8

Auvard

| a | b | |
|----|----|-----------|
| mm | mm | |
| 75 | 40 | H-1580.11 |



1/8

Auvard

| a | b | kg | lbs | |
|----|----|------|-----|-----------|
| mm | mm | | | |
| 83 | 38 | 1,14 | 2,5 | H-1582.11 |



1/8

Weissbarth
21 cm 8 1/4"

| a | b | |
|----|----|-----------|
| mm | mm | |
| 80 | 42 | H-1590.21 |

Gynecology
Gynécologie
Ginecología

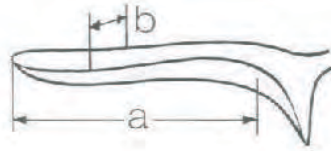

$\frac{1}{2}$

Breisky

29 cm/11 3/4"

$\frac{1}{2}$

Breisky

32 cm/12 5/8"

$\frac{1}{2}$

Breisky

35 cm/13 3/4"

$\frac{1}{2}$

Breisky

37 cm/14 3/4"

MASTPAK
SURGICAL CORPORATION

| | a | b |
|-----------|-------------|---|
| H-1710.20 | 100 x 20 mm | |
| H-1710.25 | 100 x 25 mm | |
| H-1710.30 | 100 x 30 mm | |
| H-1710.35 | 100 x 35 mm | |
| H-1710.40 | 100 x 40 mm | |

| | a | b |
|-----------|-------------|---|
| H-1713.20 | 130 x 20 mm | |
| H-1713.25 | 130 x 25 mm | |
| H-1713.30 | 130 x 30 mm | |
| H-1713.35 | 130 x 35 mm | |
| H-1713.40 | 130 x 40 mm | |

| | a | b |
|-----------|-------------|---|
| H-1716.20 | 160 x 20 mm | |
| H-1716.25 | 160 x 25 mm | |
| H-1716.30 | 160 x 30 mm | |
| H-1716.35 | 160 x 35 mm | |
| H-1716.40 | 160 x 40 mm | |

| | a | b |
|-----------|-------------|---|
| H-1718.20 | 180 x 20 mm | |
| H-1718.25 | 180 x 25 mm | |
| H-1718.30 | 180 x 30 mm | |
| H-1718.35 | 180 x 35 mm | |
| H-1718.40 | 180 x 40 mm | |

Gynecology
Gynécologie
Ginecología



Gynecology
Gynécologie
Ginecología

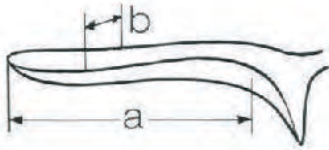

1/2

Landau
30 cm/12"

| | a | b |
|-----------|-------------|---|
| H-1783.28 | 100 x 28 mm | |
| H-1783.38 | 110 x 38 mm | |



Doyen

| | cm | in. | a | b |
|-----------|----|-------|------------|---|
| H-1793.63 | 23 | 9 | 60 x 30 mm | |
| H-1793.73 | 24 | 9 1/2 | 70 x 30 mm | |
| H-1793.83 | 25 | 10 | 80 x 30 mm | |

Gynecology
Gynécologie
Ginecología

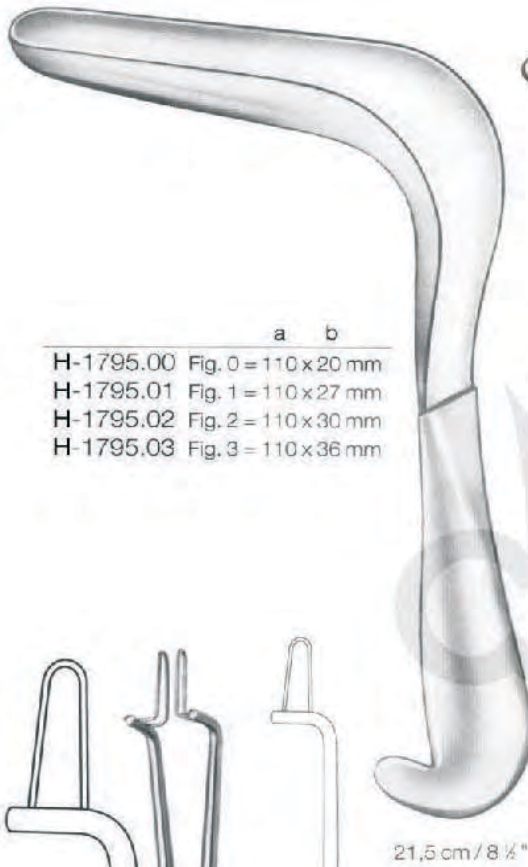

| | a | b |
|-----------|----------------------|---|
| H-1795.00 | Fig. 0 = 110 x 20 mm | |
| H-1795.01 | Fig. 1 = 110 x 27 mm | |
| H-1795.02 | Fig. 2 = 110 x 30 mm | |
| H-1795.03 | Fig. 3 = 110 x 36 mm | |

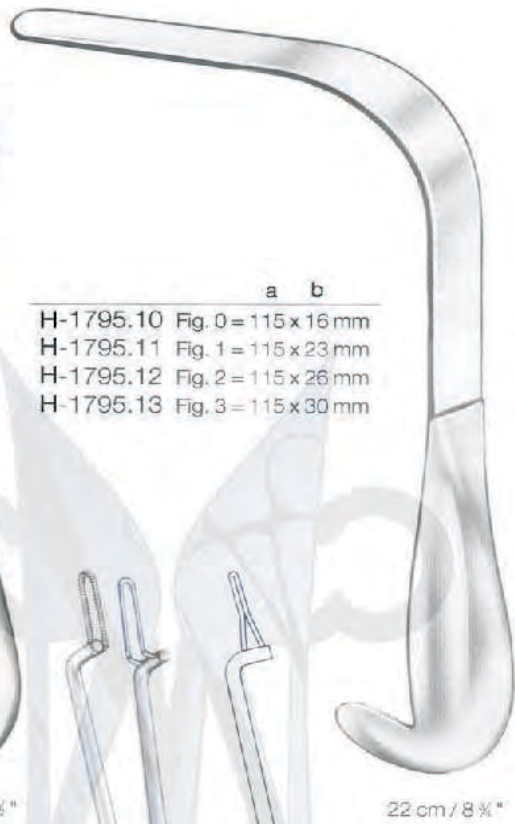

| | a | b |
|-----------|----------------------|---|
| H-1795.10 | Fig. 0 = 115 x 16 mm | |
| H-1795.11 | Fig. 1 = 115 x 23 mm | |
| H-1795.12 | Fig. 2 = 115 x 26 mm | |
| H-1795.13 | Fig. 3 = 115 x 30 mm | |

| | |
|--------|-----------|
| Fig. 0 | H-1795.20 |
| Fig. 1 | H-1795.21 |
| Fig. 2 | H-1795.22 |
| Fig. 3 | H-1795.23 |

21,5 cm / 8 1/2"

22 cm / 8 3/4"

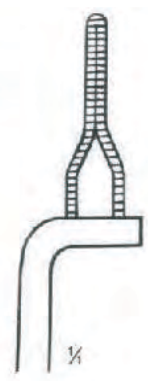

1/2"



Kogan
24 cm / 9 1/2"
H-2202.24



Kogan modif.
28 cm / 11"
H-2206.28



Kogan "Thin Line"
28 cm / 11"
H-2208.28

**Gynecology
Gynécologie
Ginecología**

Uterine Sounds

graduated in centimeters



rigid

H-2433.01

1/8

Sims
33 cm, 13"



plain

malleable

rigid

malleable

H-2433.14

H-2433.03

H-2433.34

1/8

Sims
33 cm, 13"



1/8

Valleix
30 cm, 12"
H-2483.30

Uterine Depressors



1/8

Braun
27 cm/10 1/2"
H-2511.27



1/8



1/8

Sims
26 cm/10 1/4"
H-2513.26



1/8

Doyen
17 cm/6 3/4"
H-2550.17



1/8

Doyen
15 cm, 6"
H-2552.15

MAST PAK
SURGICAL CORPORATION

Gynecology Gynécologie Ginecología

Cervical Biopsy and Specimen Forceps



Thoms-Gaylor

H-3010.22

22 cm/8 1/2"

H-3010.24

24 cm/9 1/2"

Thoms-Gaylor

H-3013.22

H-3013.24

Schubert

H-3030.21 = 21 cm/8 1/4"

H-3030.29 = 29 cm/11 1/4"

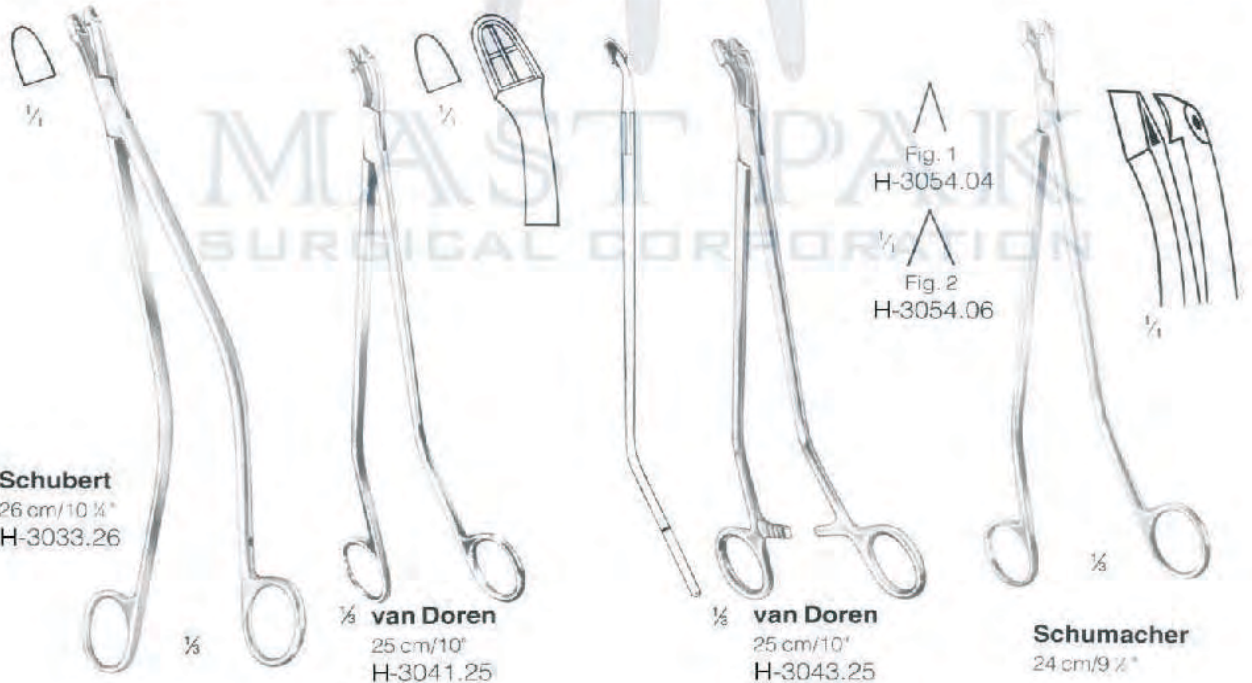

Schubert

26 cm/10 1/4"

H-3033.26

van Doren

25 cm/10"

H-3041.25

van Doren

25 cm/10"

H-3043.25

Schumacher

24 cm/9 1/2"

Fig. 1
H-3054.04

Fig. 2
H-3054.06

Gynecology
Gynécologie
Ginecología

Cervical Biopsy and Specimen Forceps

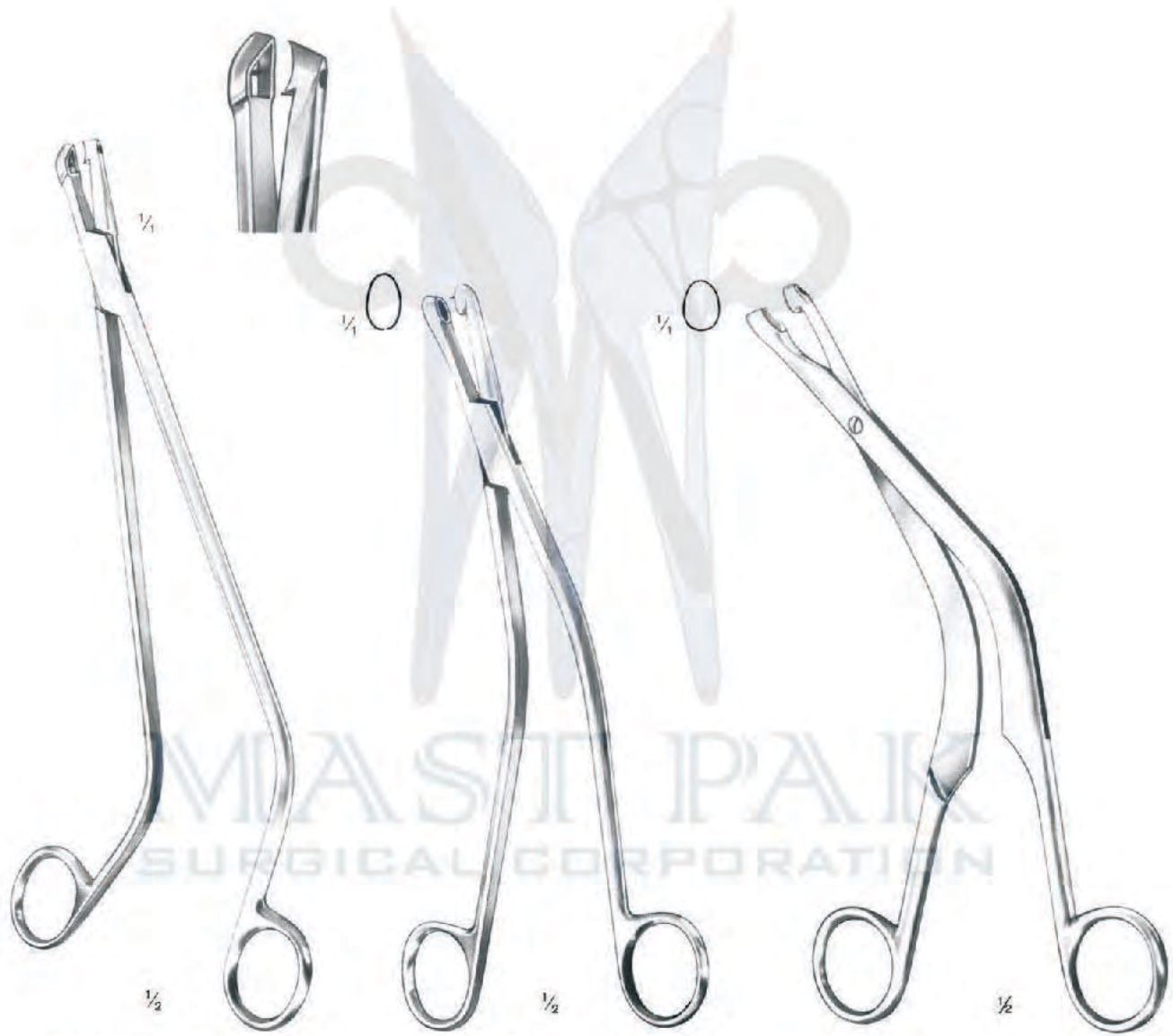

Tischler
27 cm/10 1/2"
H-3071.27

Gellhorn
23 cm/9"
H-3075.23

Faure
23 cm/9"
H-3089.23

**Gynecology
Gynécologie
Ginecología**

Cervical Biopsy and Specimen Forceps

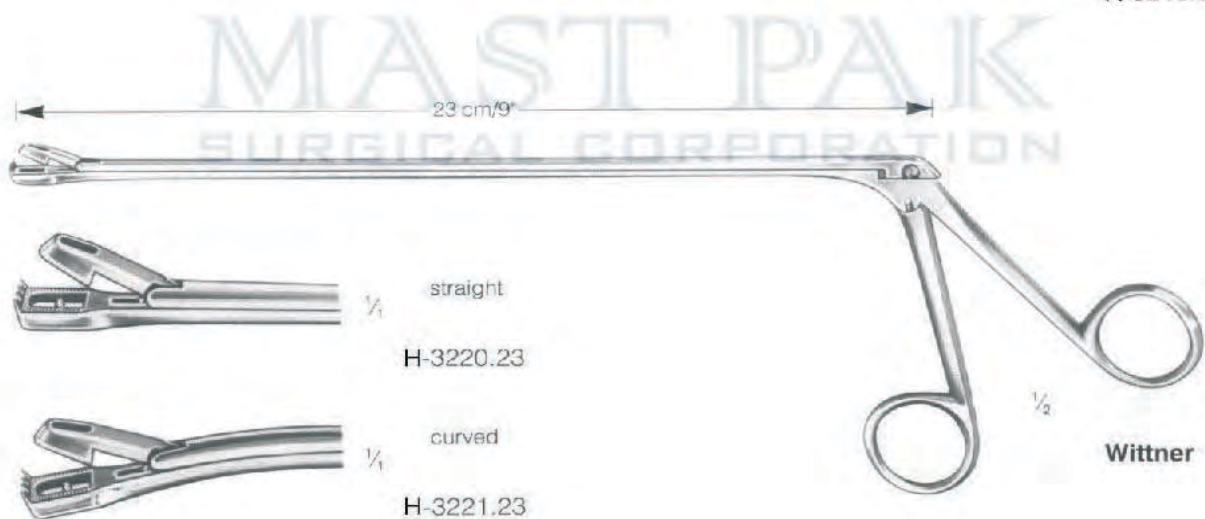
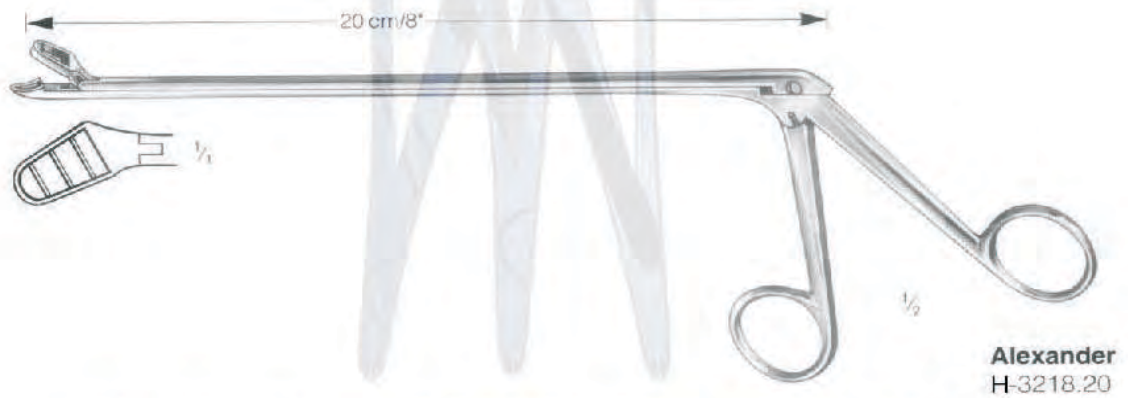

MAST PAK
 SURGICAL CORPORATION

Gynecology
Gynécologie
Ginecología

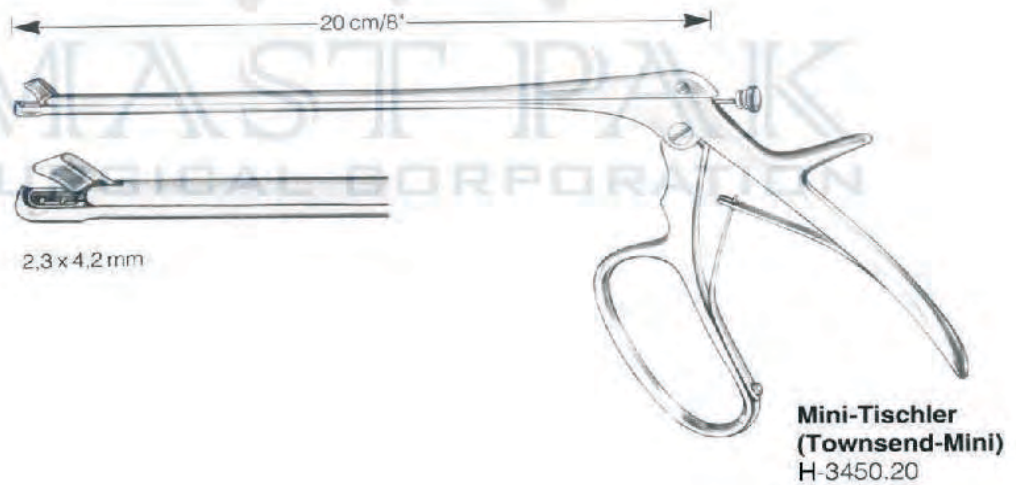
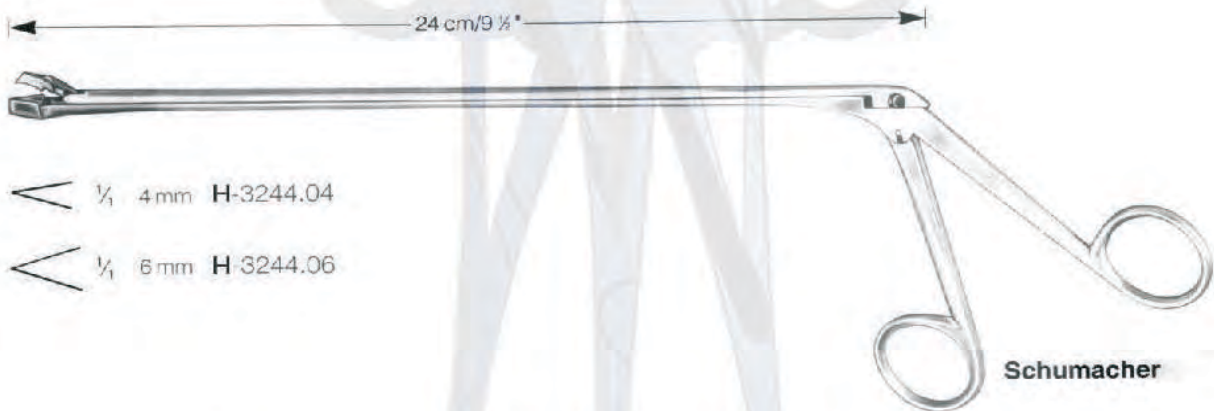

Gynecology
Gynécologie
Ginecología

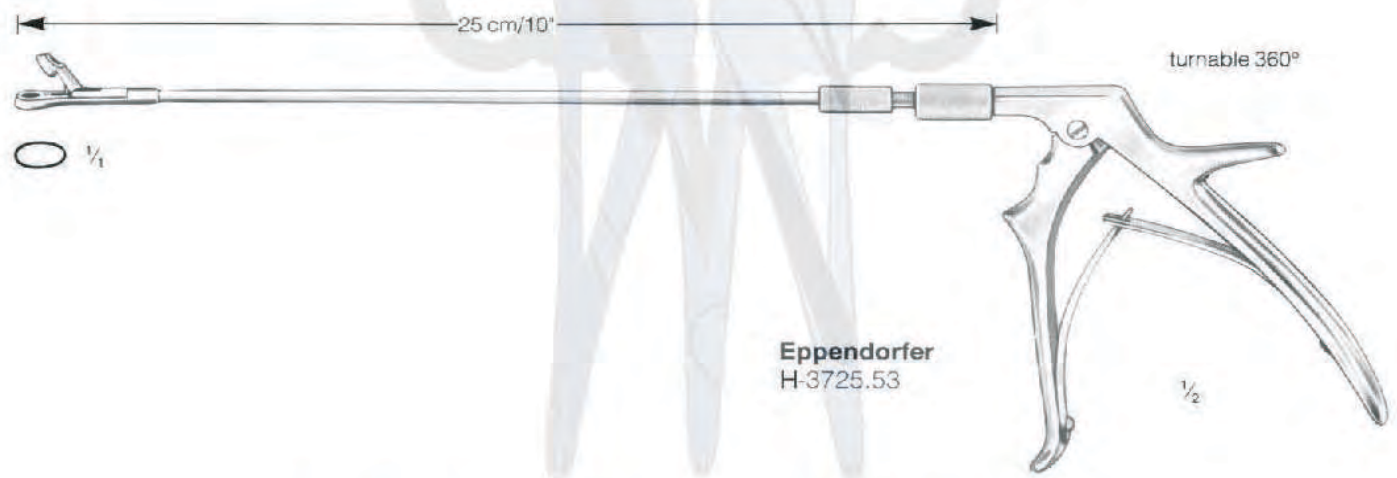
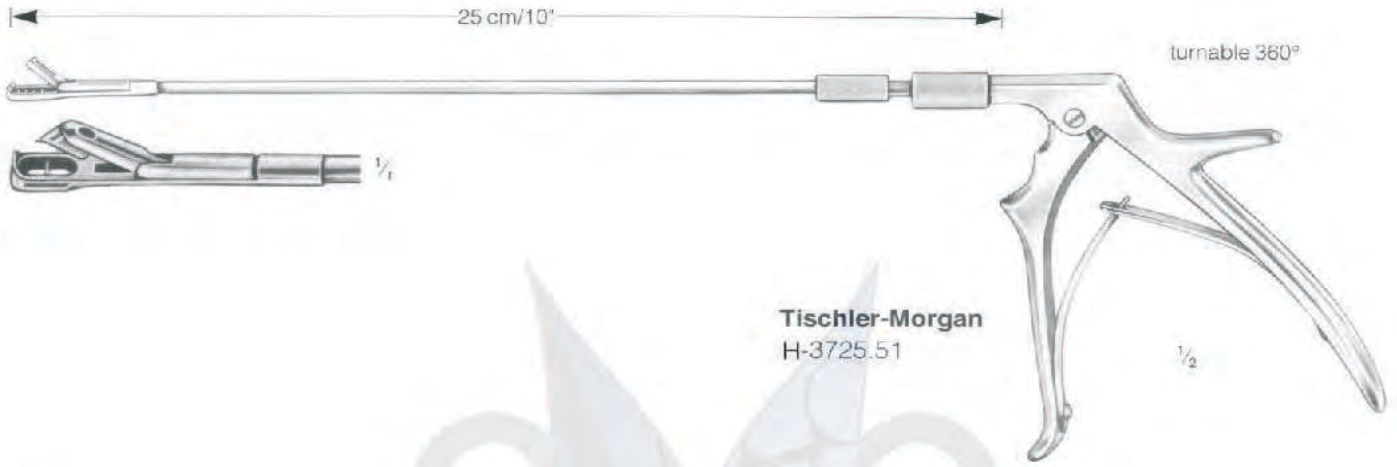

Gynecology Gynécologie Ginecología

Suction Biopsy Curettes

Uterine Biopsy Aspirating Curettes



Randall
25 cm/10"
H-4025.04

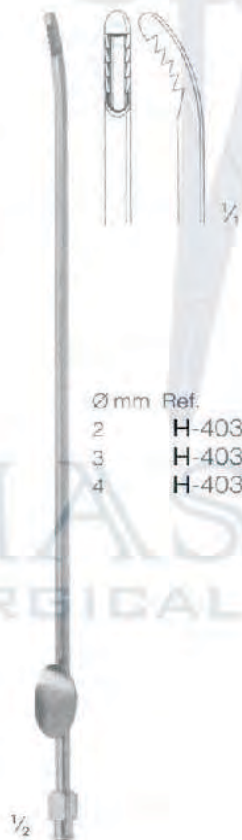

Novak
25 cm/10"
H-4035.02
H-4035.03
H-4035.04

Endometrial Biopsy Curette



Mod. Berlin
27 cm/10 3/4"
H-4067.35

Uterine Secretion Scoop



malleable
stump
blunt
romas
mousses

27.5 cm/10 3/4"
H-4092.27

MASTIPAK
SURGICAL CORPORATION

Gynecology
Gynécologie
Ginecología



CARTON
H-0570.30
30 cm/12"
5 mm dia



BOZEMANN-FRITSCH
H-0590.08 8 mm dia
H-0590.10 10 mm dia
H-0590.12 12 mm dia



SPACKMANN
H-0610.18
18 cm/7"

MAST PAK
SURGICAL CORPORATION

Uterine Cannula



SPACKMANN
H-0620.35

Gynecology
Gynécologie
Ginecología

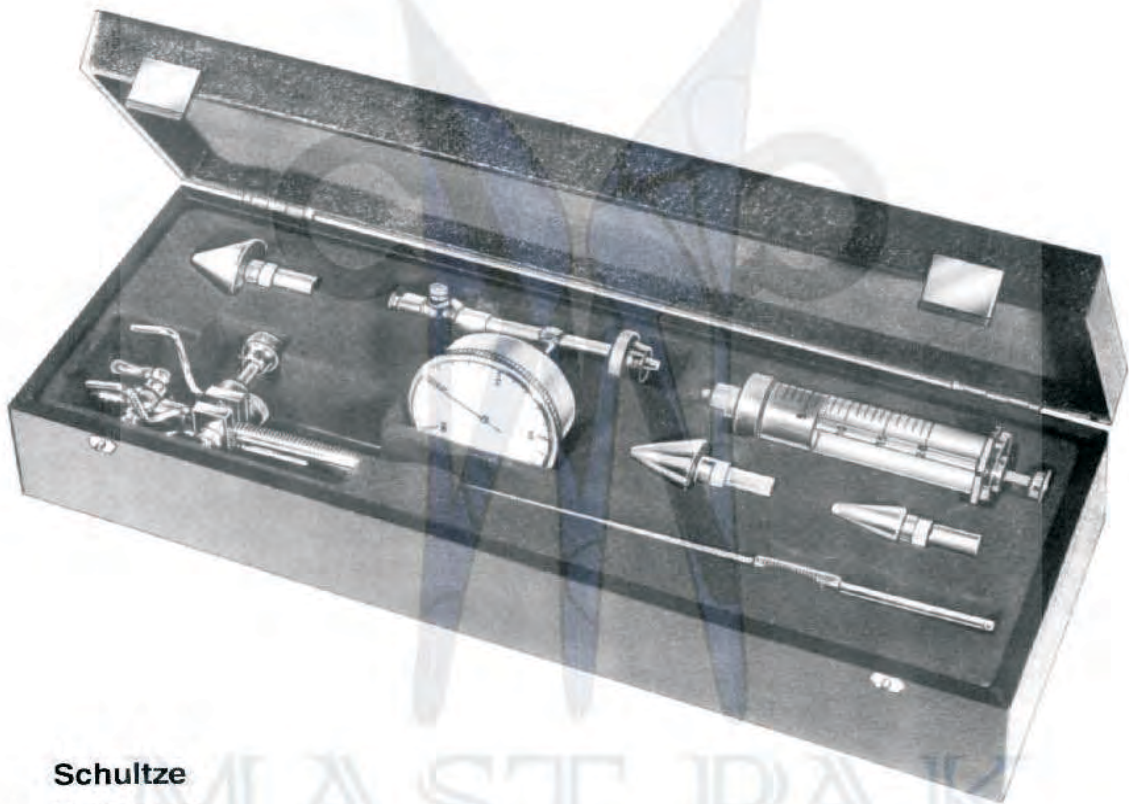

Schultze

H-4820.40
Salpingograph

MAST PAK
SURGICAL CORPORATION

Uterine Curettes, Uterine Scoops



Gynecology
Gynécologie
Ginecología

Uterine Curettes

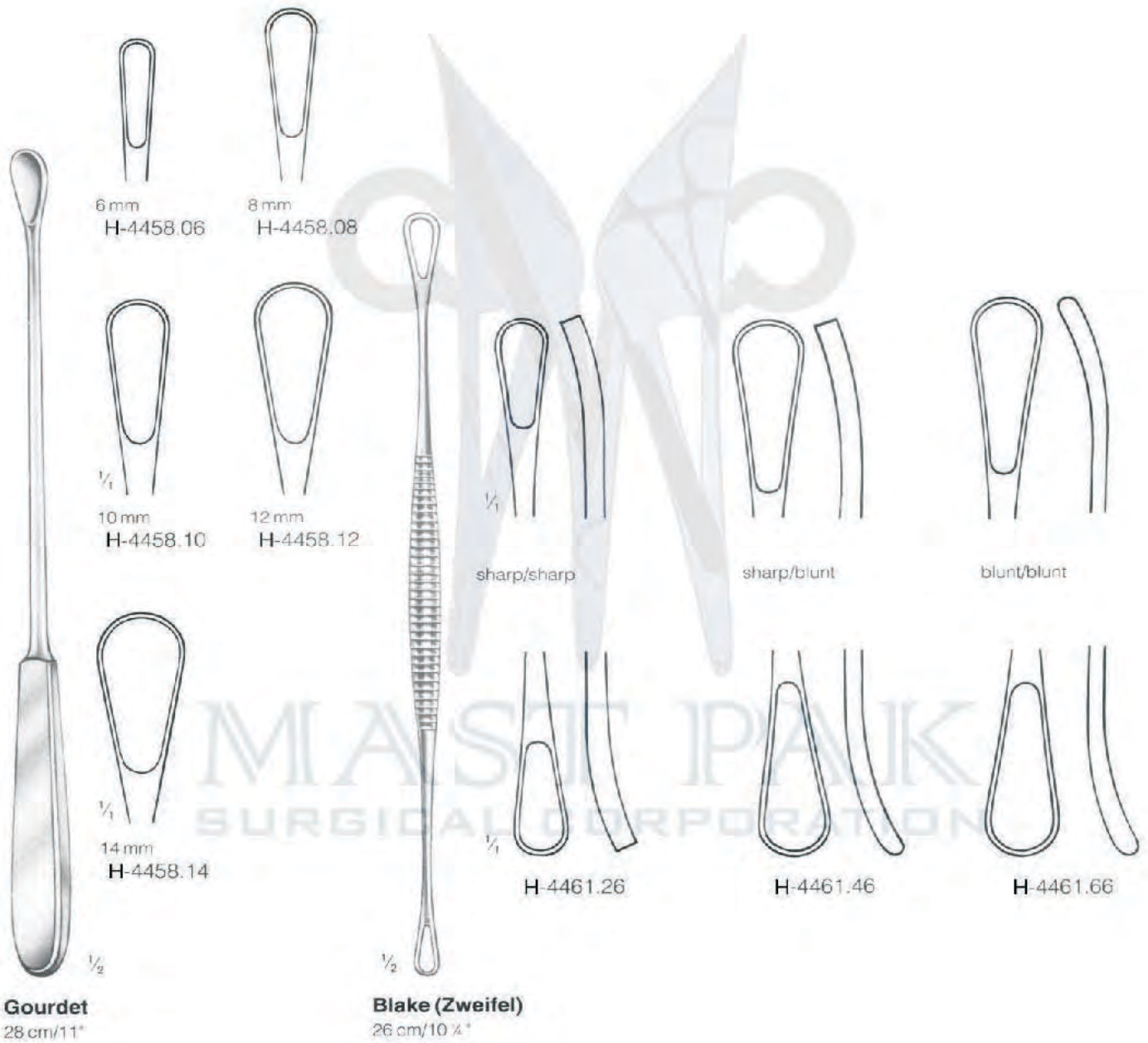



Recamier
max. 31 cm / 12 1/2"

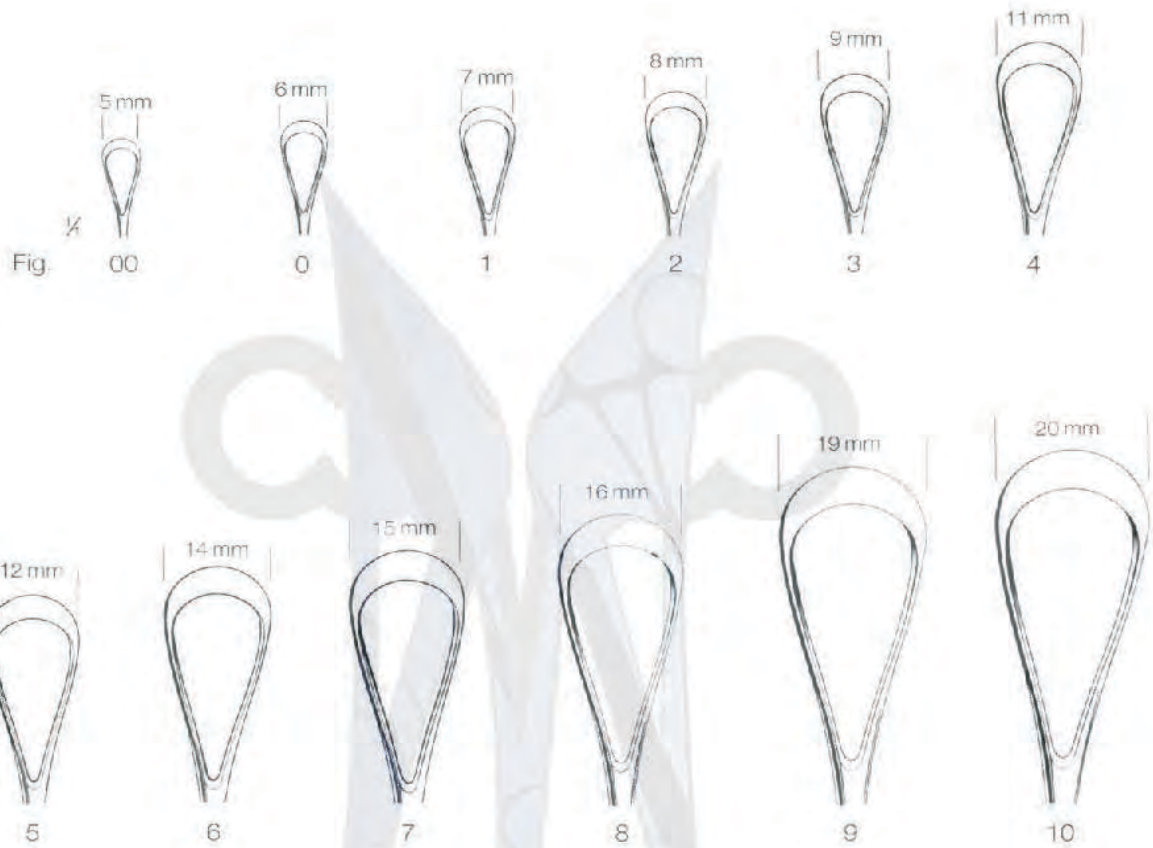

sharp

blunt

rigid

malleable

rigid

malleable

| | | Fig. | | |
|-----------|-----------|------|-----------|-----------|
| H-4510.05 | H-4511.05 | 00 | H-4512.05 | H-4513.05 |
| H-4510.06 | H-4511.06 | 0 | H-4512.06 | H-4513.06 |
| H-4510.07 | H-4511.07 | 1 | H-4512.07 | H-4513.07 |
| H-4510.08 | H-4511.08 | 2 | H-4512.08 | H-4513.08 |
| H-4510.09 | H-4511.09 | 3 | H-4512.09 | H-4513.09 |
| H-4510.11 | H-4511.11 | 4 | H-4512.11 | H-4513.11 |
| H-4510.12 | H-4511.12 | 5 | H-4512.12 | H-4513.12 |
| H-4510.14 | H-4511.14 | 6 | H-4512.14 | H-4513.14 |
| H-4510.15 | H-4511.15 | 7 | H-4512.15 | H-4513.15 |
| H-4510.16 | H-4511.16 | 8 | H-4512.16 | H-4513.16 |
| H-4510.19 | H-4511.19 | 9 | H-4512.19 | H-4513.19 |
| H-4510.20 | H-4511.20 | 10 | H-4512.20 | H-4513.20 |

Uterine Curettes



Gynecology
Gynécologie
Ginecología

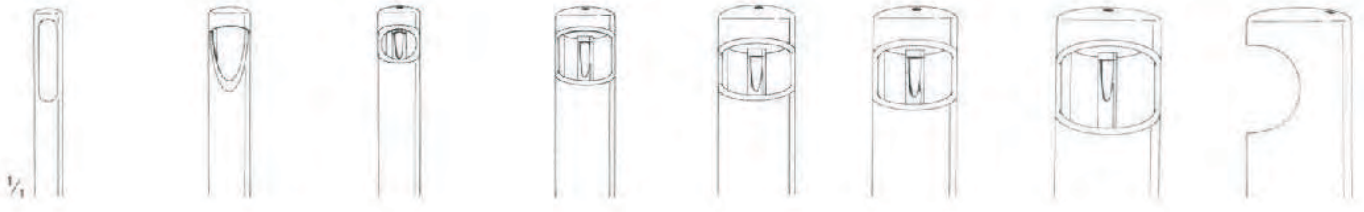

H-4601.03 3 mm Ø H-4601.04 4,5 mm Ø H-4601.06 6 mm Ø H-4601.08 8 mm Ø H-4601.10 10 mm Ø H-4601.12 12 mm Ø H-4601.14 14 mm Ø H-4601.50

Specimen and Aspirating Curettes

Aspirating Curettes

Hose Connection

**Obstetrics
Obstétrique
Obstetricia**



¼

Breisky
33 cm/ 13"
H-6010.33



¼

Collyer
30.5 cm/ 12"
H-6030.30



¼

H-6040.34
cm/inches scale

Martin
34 cm/ 13 ½"

H-6041.34
cm scale



Naegele
H-7310.36 = 36 cm/ 14"
H-7310.40 = 40 cm/ 15 ½"



¼

Kielland
41 cm/ 16 ¼"
H-7330.41



¼

Piper
44 cm/ 17 ½"
H-7335.44



¼

Simpson
30.5 cm/ 12"
H-7374.30

MALSTRAK
SURGICAL CORPORATION

**Obstetrics
Obstétrique
Obstetricia**



WRIGLEY
H-7310.23 23 cm



ELLIOT
H-7402.32 32cm
H-7402.38 38cm



SIMPSON.LUIKART
H-7410.36 36cm



LUIKART
H-7410.40 40cm



DE LEE
H-7312.30 30cm
H-7312.36 36cm
H-7312.39 39cm



Kielland-luikart
H-7414.40



Simpson-Braun
36 cm/14"
H-7374.36



Boerma
29 cm/11 1/2"
H-7402.29



Sellheim
28 cm/11"
H-7205.28



LUIKART-BILL
H-3171.21

Obstetrics
Obstétrique
Obstetricia

Placenta and Ovum Curettes, Scoops



Obstetrics
 Obstétrique
 Obstetricia



Fig. 11
21 mm



Fig. 12
23 mm



Fig. 13
25 mm



Fig. 14
30 mm
sharp
rigid



Fig. 15
35 mm
malleable



Fig. 16
40 mm
blunt
rigid malleable

Recamier-Bumm

31 cm / 12 1/2"

Fig.

| | | | | |
|-----------|-----------|----|-----------|-----------|
| H-4510.21 | H-4511.21 | 11 | H-4512.21 | H-4513.21 |
| H-4510.23 | H-4511.23 | 12 | H-4512.23 | H-4513.23 |

34 cm / 13 1/2"

Fig.

| | | | | |
|-----------|-----------|----|-----------|-----------|
| H-4510.25 | H-4511.25 | 13 | H-4512.25 | H-4513.25 |
| H-4510.30 | H-4511.30 | 14 | H-4512.30 | H-4513.30 |
| H-4510.35 | H-4511.35 | 15 | H-4512.35 | H-4513.35 |
| H-4510.40 | H-4511.40 | 16 | H-4512.40 | H-4513.40 |

**Obstetrics
Obstétrique
Obstetricia**

Umbilical Cord Clamps



½

Kane
8,5 cm, 3 ½"
H-8210.85



½

Collin
9 cm, 3 ½"
H-8212.90

Amniotomes for the



½

Beacham
28 cm / 10 ¾"
H-7910.26

transvaginal injection for paracervical anaesthesia

Trumpet Needle Guide



½

lowa
14 cm, 5 ¼"
H-8310.14



½

lowa
14 cm, 5 ½"
H-8311.14



½

lowa
Injection Needle
1.00 x 160 mm
Luer-Lock
H-8312.16

MAST PAK
SURGICAL CORPORATION

Gynecology Retractors

Abdominal retractors and spatulas
Ecarteurs à paroi abdominale
Separadores abdominales y espátulas



50 x 85 mm

1/2

Doyen
25 cm/10"
G-2335.85

70 x 25 mm

1/2

1/2

Kocher
22.5 cm/9"
G-2342.25

80 mm

1/2

1/2

Kocher
25 cm/10"

- G-2345.42 = 80 x 42 mm
- G-2345.50 = 80 x 50 mm
- G-2345.60 = 80 x 60 mm

MAST PAK
SURGICAL CORPORATION

Abdominal retractors and spatulas
Ecarteurs à paroi abdominale
Separadores abdominales y Espátulas



Mikulicz
26 cm/10 1/4"
G-2360.85

Mikulicz
26 cm/10 1/4"
G-2361.20 = 120 x 50 mm
G-2361.55 = 155 x 50 mm

Abdominal and vaginal retractors
Ecarteurs abdominaux et vaginaux
Separadores abdominales y vaginales

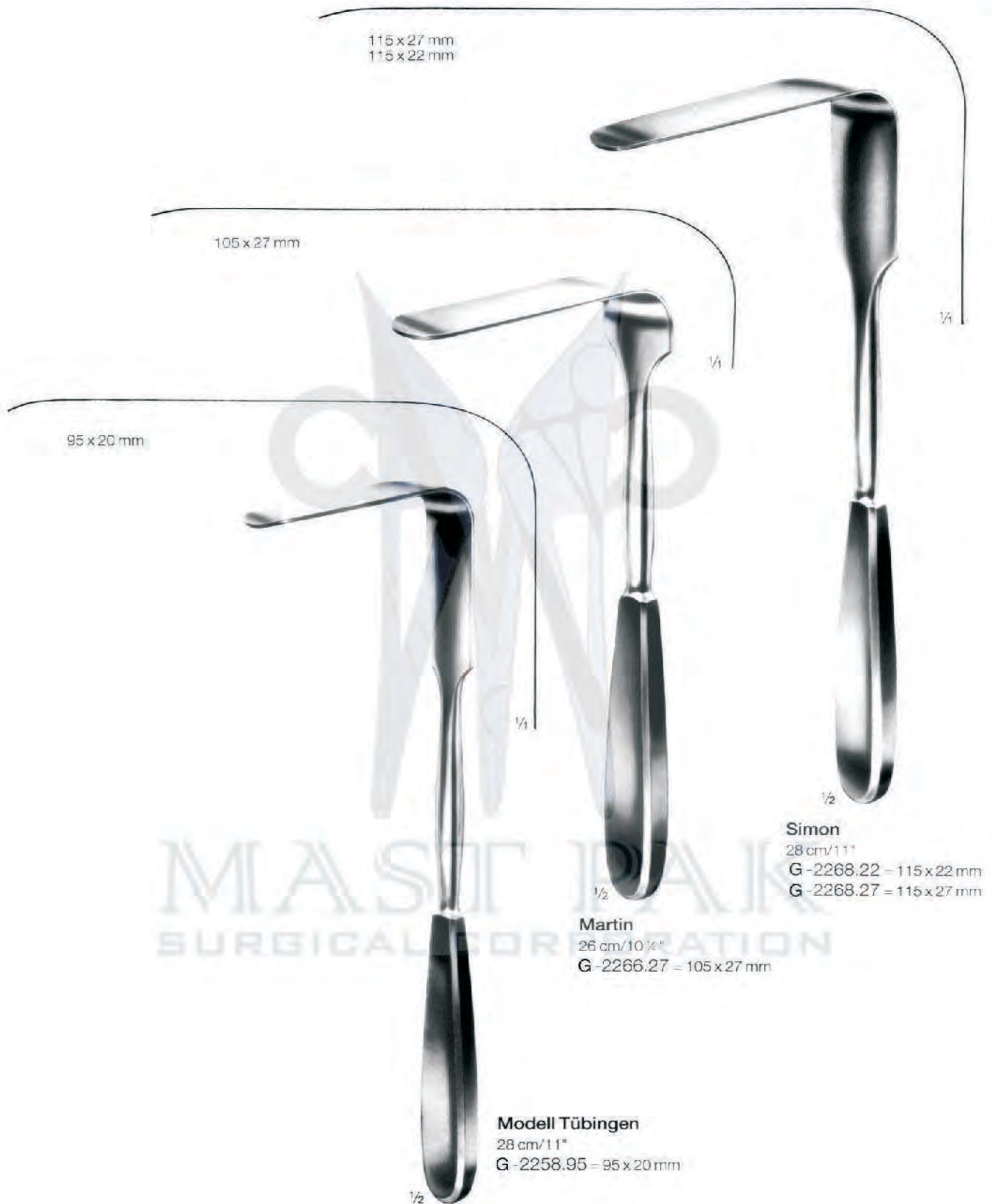

Abdominal and vaginal retractors
Ecarteurs abdominaux et vaginaux
Separadores abdominales y vaginales



Fig.

| | | |
|---|-----------|-------------|
| 1 | G-3435.06 | 60 x 35 mm |
| 2 | G-3435.09 | 90 x 35 mm |
| 3 | G-3435.12 | 120 x 35 mm |
| 4 | G-3435.14 | 140 x 35 mm |
| 5 | G-3435.16 | 160 x 35 mm |
| 6 | G-3435.18 | 180 x 35 mm |

| | | |
|---|-----------|-------------|
| 1 | G-3445.06 | 60 x 45 mm |
| 2 | G-3445.09 | 90 x 45 mm |
| 3 | G-3445.12 | 120 x 45 mm |
| 4 | G-3445.14 | 140 x 45 mm |
| 5 | G-3445.16 | 160 x 45 mm |
| 6 | G-3445.18 | 180 x 45 mm |

| | | |
|---|-----------|-------------|
| 1 | G-3460.06 | 60 x 60 mm |
| 2 | G-3460.09 | 90 x 60 mm |
| 3 | G-3460.12 | 120 x 60 mm |
| 4 | G-3460.14 | 140 x 60 mm |
| 5 | G-3460.16 | 160 x 60 mm |
| 6 | G-3460.18 | 180 x 60 mm |

Fig.

| | | |
|---|-----------|-------------|
| 1 | G-3535.06 | 60 x 35 mm |
| 2 | G-3535.09 | 90 x 35 mm |
| 3 | G-3535.12 | 120 x 35 mm |
| 4 | G-3535.13 | 130 x 35 mm |

| | | |
|---|-----------|-------------|
| 1 | G-3545.06 | 60 x 45 mm |
| 2 | G-3545.09 | 90 x 45 mm |
| 3 | G-3545.12 | 120 x 45 mm |
| 4 | G-3545.13 | 130 x 45 mm |

| | | |
|---|-----------|-------------|
| 1 | G-3560.06 | 60 x 60 mm |
| 2 | G-3560.09 | 90 x 60 mm |
| 3 | G-3560.12 | 120 x 60 mm |
| 4 | G-3560.13 | 130 x 60 mm |

Vaginal retractors
Ecarteurs vulvaires
Separadores para la vulva



Gelpi
9 cm/3 1/2" = G-6830.09
11 cm/4 1/4" = G-6830.11
14 cm/5 1/2" = G-6830.14



Gelpi
19 cm/7 1/2" =
G-6830.19



Gelpi
19 cm/7 1/2" =
G-6832.19

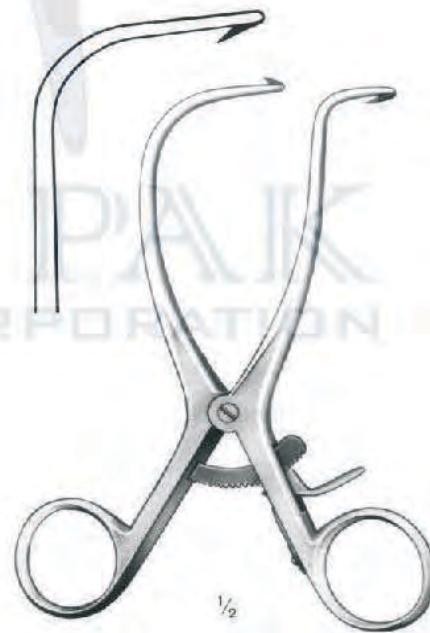

Seletz-Gelpi
15 cm/6" =
G-6834.15

Gynecology Scissors

Gynecological scissors
Ciseaux gynécologiques
Tijeras para ginecología



straight

Sims
F-1550.##

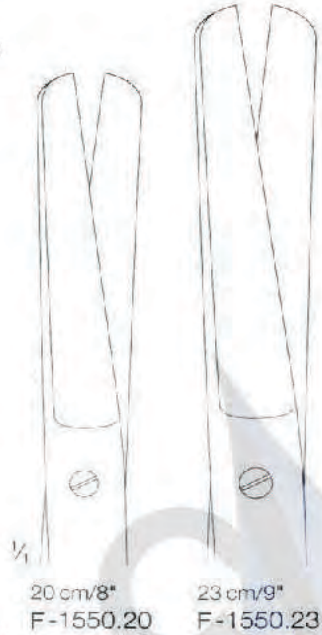

1/4
20 cm/8"
F-1550.20

23 cm/9"
F-1550.23



curved

Sims
F-1551.##



1/4
20 cm/8"
F-1551.20

23 cm/9"
F-1551.23

Abdominal Scissors,



1/2

Doyen
16 cm/8 1/4"



1/4
F-1580.16

straight

F-1581.16

curved



1/2

Doyen
18 cm/7"



1/4
F-1580.18

straight

F-1581.18

curved

MAST PAIK
SURGICAL CORPORATION

Gynecological scissors
Ciseaux gynécologiques
Tijeras para ginecología

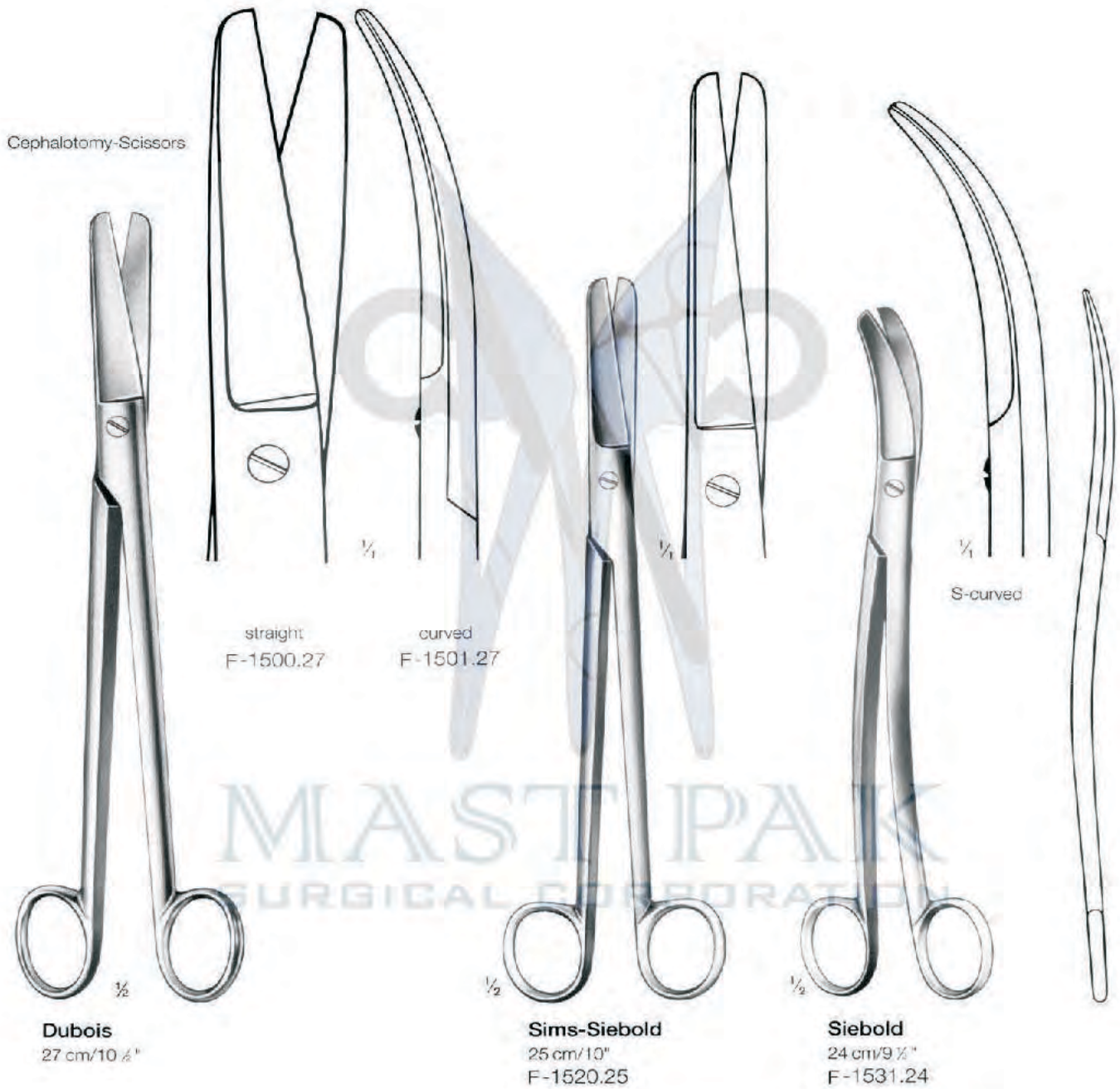

Gynecological scissors
Ciseaux gynécologiques
Tijeras para ginecología



Gynecological scissors
Ciseaux gynécologiques
Tijeras para ginecología

Umbilical Cord Scissors



MAST PAK
SURGICAL CORPORATION

Gynecological scissors
Ciseaux gynécologiques
Tijeras para ginecología



Braun-Stadler
14 cm/5 1/2"
F-1605.14

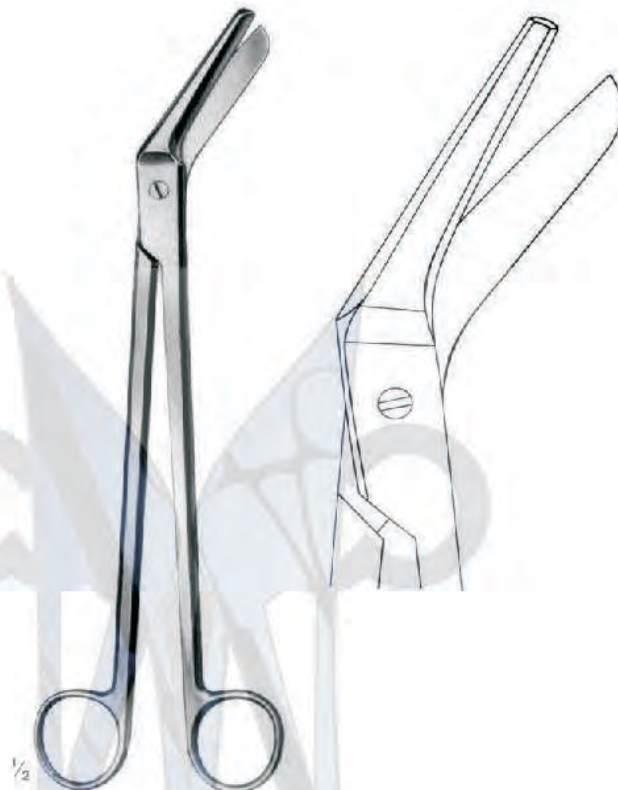

Braun-Stadler
22 cm/8 3/4"
F-1605.22



Marbach
15,5 cm/6"
F-1613.15

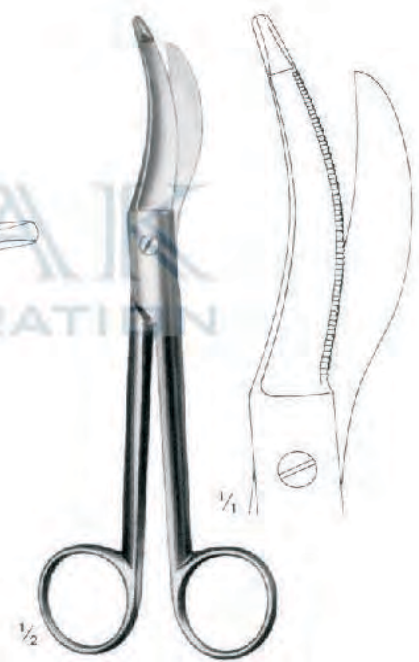
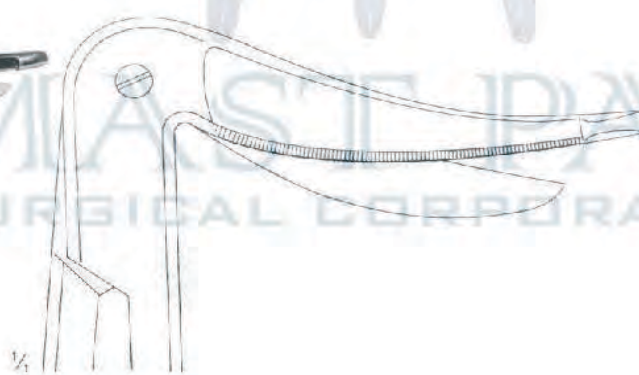

Waldmann
18 cm/7"
F-1617.18

Ligature scissors, parametrium scissors
Ciseaux à ligatures, Ciseaux Parametrium
Tijeras para ligaduras, Tijeras Parametrium

Ligature Scissors



1 Blade serrated



1/4



TC.9155.14
14,5 cm/5 1/2"

TC.9155.18
18 cm/7"

TC.9155.20
20 cm/8"

TC.9155.23
23 cm/9"

02-9155.25
25 cm/10"

Parametrium Scissors



1/2

Parametrium



light curve



1/4

TC.9411.23
23 cm/9"

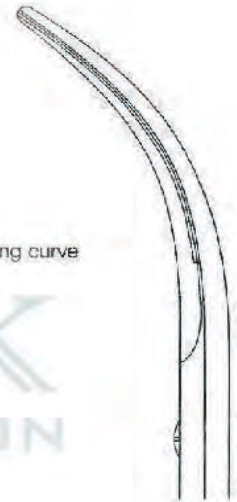

strong curve

TC.9413.22
22 cm/8 1/2"

Gynecology Miscellaneous

**Various knives
Couteaux divers
Varios cuchillos**

Transplantation Knives

Cone Knives

Mycma Knife



1/2

Thiersch
20 cm/8"
A - 0331.20



Rehn
23 cm/9"
A - 0336.23



1/4

23 cm/9"
A - 0361.23



1/4

Ayre
23.5 cm/9 1/4"
A - 0361.24



1/4

Segond
27 cm/10 1/2"
A - 0380.27

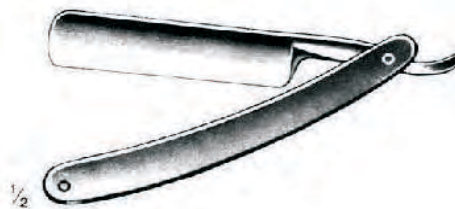

1/2

A - 0340.06

Suction tubes
Tubes d'aspiration
Tubos aspiradores

Trocars
Trocarts
Trócares



Metal female catheters

| | mm Ø | Charr. |
|-----------|-------|--------|
| B-2951.06 | 2 | 6 |
| B-2951.07 | 2 1/2 | 7 |
| B-2951.08 | 2 1/2 | 8 |
| B-2951.09 | 3 | 9 |
| B-2951.10 | 3 1/2 | 10 |
| B-2951.11 | 3 1/2 | 11 |
| B-2951.12 | 4 | 12 |
| B-2951.14 | 4 1/2 | 14 |
| B-2951.16 | 5 1/2 | 16 |
| B-2951.18 | 6 | 18 |
| B-2951.20 | 6 1/2 | 20 |
| B-2951.22 | 7 1/2 | 22 |
| B-2951.24 | 8 | 24 |

16 cm/6 1/4"



B-3003.00
 Universal trocar with 3 tips fig. 2, 3, 4

B-3004.00
 Universal trocar with 4 tips

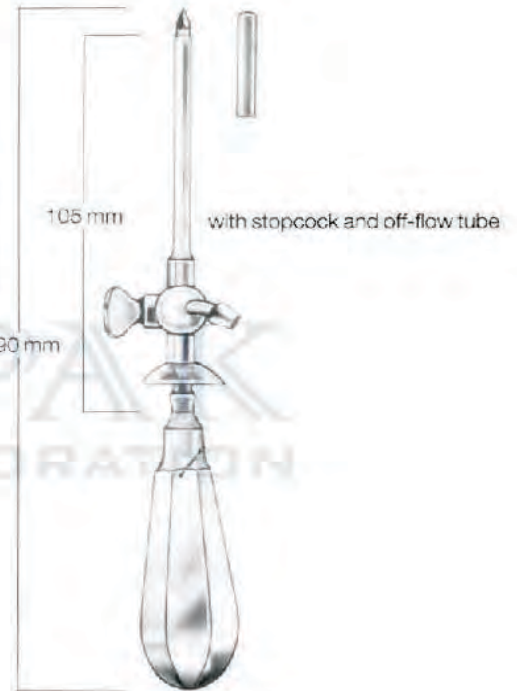
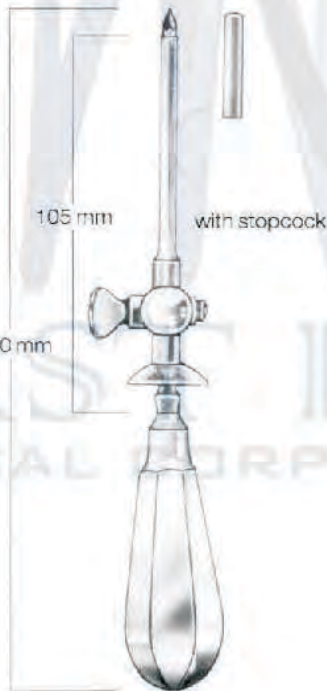
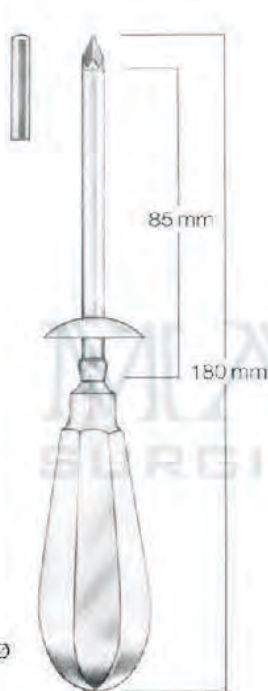

inside Ø outside Ø

| mm | mm | Standard |
|----|----|-----------|
| 2 | 3 | B-3010.30 |
| 3 | 4 | B-3010.40 |
| 4 | 5 | B-3010.50 |
| 5 | 6 | B-3010.60 |

| Standard |
|-----------|
| B-3012.30 |
| B-3012.40 |
| B-3012.50 |
| B-3012.60 |

| Standard |
|-----------|
| B-3014.30 |
| B-3014.40 |
| B-3014.50 |
| B-3014.60 |

Dilators Dilatateurs Dilatadores

Set of Dilating Sounds

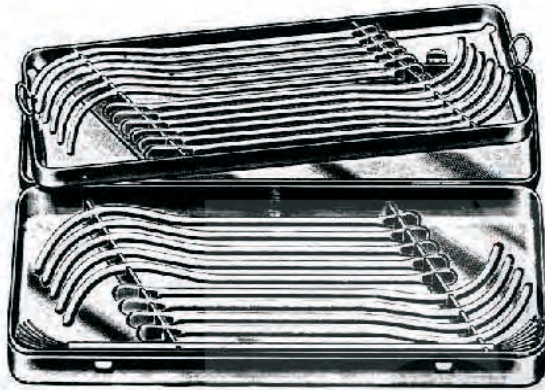

Set of Urethral Bougies and Dilating Sounds in metal case, containing:
21 Urethral Bougies, 10-11-12-13-14-15-16-17-18-
19-20-21-22-23-24-25-26-27-28-29-30
6 Filiform bougies in metal tube

¾

420 x 175 x 40 mm

Guyon

B-6174.21



½

Hank

| | | |
|-----------|------------|-------------|
| B-6240.09 | Fig. 9/10 | 4,5/ 5 mm Ø |
| B-6240.11 | Fig. 11/12 | 5,5/ 6 mm Ø |
| B-6240.13 | Fig. 13/14 | 6,5/ 7 mm Ø |
| B-6240.15 | Fig. 15/16 | 7,5/ 8 mm Ø |
| B-6240.17 | Fig. 17/18 | 8,5/ 9 mm Ø |
| B-6240.19 | Fig. 19/20 | 9,5/10 mm Ø |

Set of 6 dilators (9/10 - 19/20),
in canvas roll No. B-6241.96



½

Hank

B-6241.06

Uterine dilators
Dilatateurs utérins
Dilatadores uterinos



Hegar

| | | | | | |
|------|-----------|-----------|------|-----------|-----------|
| mm Ø | B-6320.01 | | mm Ø | | B-6331.25 |
| 1,0 | | B-6330.15 | 12,5 | | |
| 1,5 | B-6320.02 | | 13,0 | B-6320.13 | B-6331.35 |
| 2,0 | | B-6330.25 | 13,5 | | |
| 2,5 | B-6320.03 | | 14,0 | B-6320.14 | B-6331.45 |
| 3,0 | | B-6330.35 | 14,5 | | |
| 3,5 | B-6320.04 | | 15,0 | B-6320.15 | B-6331.55 |
| 4,0 | | B-6330.45 | 15,5 | | |
| 4,5 | B-6320.05 | | 16,0 | B-6320.16 | B-6331.65 |
| 5,0 | | B-6330.55 | 16,5 | | |
| 5,5 | B-6320.06 | | 17,0 | B-6320.17 | B-6331.75 |
| 6,0 | | B-6330.65 | 17,5 | | |
| 6,5 | B-6320.07 | | 18,0 | B-6320.18 | |
| 7,0 | | B-6330.75 | 19,0 | B-6320.19 | |
| 7,5 | B-6320.08 | | 20,0 | B-6320.20 | |
| 8,0 | | B-6330.85 | 21,0 | B-6320.21 | |
| 8,5 | B-6320.09 | | 22,0 | B-6320.22 | |
| 9,0 | | B-6330.95 | 23,0 | B-6320.23 | |
| 9,5 | B-6320.10 | | 24,0 | B-6320.24 | |
| 10,0 | | B-6331.05 | 25,0 | B-6320.25 | |
| 10,5 | B-6320.11 | | 26,0 | B-6320.26 | |
| 11,0 | | B-6331.15 | | | |
| 11,5 | B-6320.12 | | | | |
| 12,0 | | | | | |

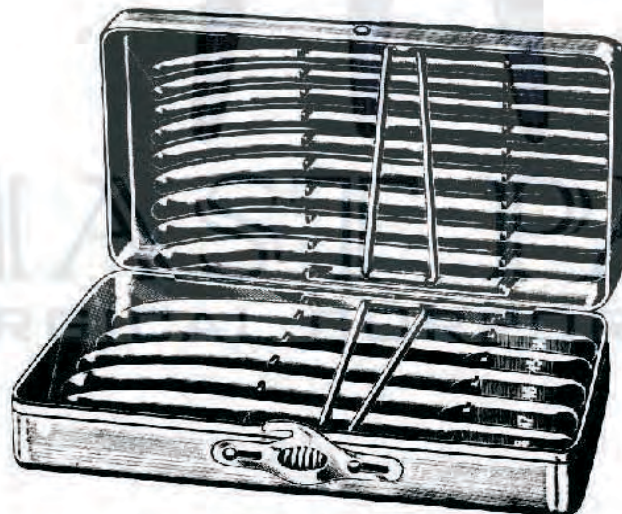

B-6325.14

Set of 14 dilators 4 – 17 mm Ø in meta. case

B-6325.26

Set of 26 dilators 1 – 26 mm Ø in meta. case

Uterine dilators
Dilatateurs utérins
Dilatadores uterinos



Hegar

| | mm Ø |
|-----------|--------|
| B-6350.01 | 1+ 2 |
| B-6350.03 | 3+ 4 |
| B-6350.05 | 5+ 6 |
| B-6350.07 | 7+ 8 |
| B-6350.09 | 9+ 10 |
| B-6350.11 | 11+ 12 |
| B-6350.13 | 13+ 14 |
| B-6350.15 | 15+ 16 |
| B-6350.17 | 17+ 18 |
| B-6350.19 | 19+ 20 |
| B-6350.21 | 21+ 22 |
| B-6350.23 | 23+ 24 |
| B-6350.25 | 25+ 26 |

B-6351.08
 Set of 8 dilators
 3.0/4.0 - 17.0/18.0 mm Ø.

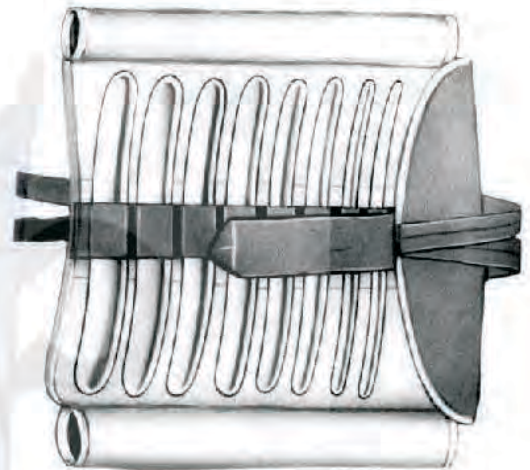

Hegar
B-6352.08
 Set of 8 dilators
 3.0/4.0 - 17.0/18.0 mm Ø.
 In metal case with hinged lid

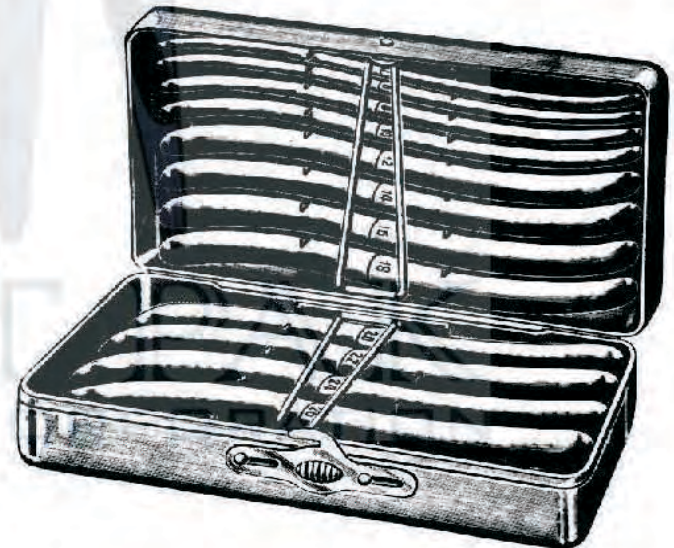

Hegar
B-6352.13
 Set of 13 dilators
 1.0/2.0 - 25.0/26.0 mm Ø.
 In metal case with hinged lid

**Diagnostics
Diagnostic
Diagnostico**

Stethoscopes





Mast Pak

Surgical Corporation

Manufacturer & Exporters of surgical instruments

Website: www.mastpaksurgicalcorp.com

Email: info@mastpaksurgicalcorp.com

Phone: +92-324-8609456

Address: Pacca Garha, Kashmir Road
Sialkot 51310, Pakistan